

MUR820 THRU MUR860

GLASS PASSIVATED SUPER FAST RECTIFIER

Reverse Voltage - 200 -600 Volts Forward Current - 8.0Amperes

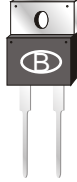

TO-220AC

Features

- ✧ High efficiency, Low VF
- ✧ High current capability
- ✧ High reliability
- ✧ High surge current capability
- ✧ For use in low voltage, high frequency inverter, free wheeling, and polarity protection application.

Mechanical Data

- ✧ Cases: TO-220AC molded plastic
- ✧ Epoxy: UL 94V-0 rate flame retardant
- ✧ Terminals: Pure tin plated, lead free, solderable per MIL-STD-202, Method 208 guaranteed
- ✧ Polarity: As marked
- ✧ High temperature soldering guaranteed:
260°C/10 seconds/.25", (6.35mm) from case.
- ✧ Weight: 2.24 grams

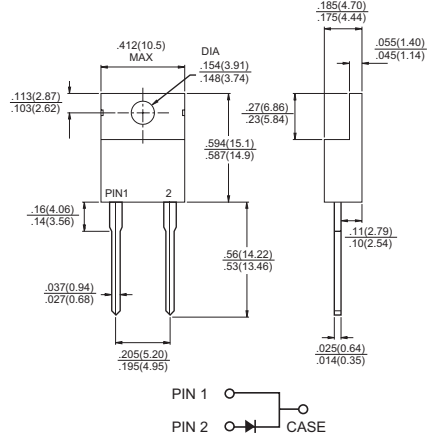

Dimensions in inches and (millimeters)

Maximum Ratings and Electrical Characteristics

Rating at 25 °C ambient temperature unless otherwise specified.

Single phase, half wave, 60 Hz, resistive or inductive load.

For capacitive load, derate current by 20%

Type Number	Symbol	MUR820	MUR840	MUR860	Units
Maximum Recurrent Peak Reverse Voltage	V_{RRM}	200	400	600	V
Maximum RMS Voltage	V_{RMS}	140	280	420	V
Maximum DC Blocking Voltage	V_{DC}	200	400	600	V
Maximum Average Forward Rectified Current .375"(9.5mm) Lead Length (See Fig. 1)	$I_{(AV)}$	8.0			A
Peak Forward Surge Current, 8.3 ms Single Half Sine-wave Superimposed on Rated Load (JEDEC method)	I_{FSM}	100			A
Maximum Instantaneous Forward Voltage @ 8.0A	V_F	0.975	1.30	1.7	V
Maximum DC Reverse Current @ $T_C=25^\circ C$ at Rated DC Blocking Voltage @ $T_C=125^\circ C$ (Note 4)	I_R	5.0 250			μA μA
Maximum Reverse Recovery Time (Note 2)	T_{rr}	25	50		nS
Maximum Forward Recovery Time TFR ($I_F=1.0A$, $di/dt = 50A/\mu S$),	T_{fr}	35	50		nS
Typical Thermal Resistance (Note 3)	$R_{\theta JC}$	3.0	2.0		$^\circ C/W$
Operating Temperature Range	T_J	-65 to +175			$^\circ C$
Storage Temperature Range	T_{STG}	-65 to +175			$^\circ C$

- Notes:
1. Measured at 1 MHz and Applied Reverse Voltage of 4.0 Volts D.C.
 2. Reverse Recovery Test Conditions: $I_F=0.5A$, $I_R=1.0A$, $I_{RR}=0.25A$
 3. Thermal Resistance from Junction to Case, Mounted on Heatsink Size of 2" x 3" x 0.25" Al-Plate.
 4. Pulse lest: $t_p = 300 \mu s$, Duty Cycle < 2%.

RATINGS AND CHARACTERISTIC CURVES (MUR820 THRU MUR860)

FIG.1- MAXIMUM FORWARD CURRENT DERATING CURVE

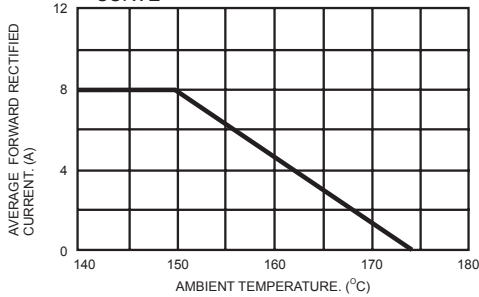

FIG.2- MAXIMUM NON-REPETITIVE FORWARD SURGE CURRENT

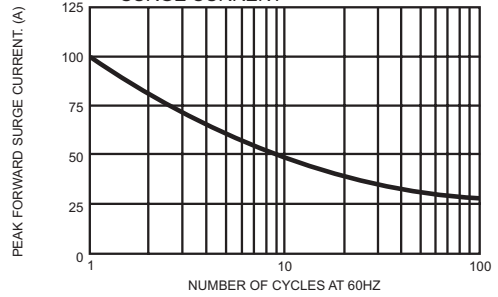

FIG.3- TYPICAL INSTANTANEOUS FORWARD CHARACTERISTICS

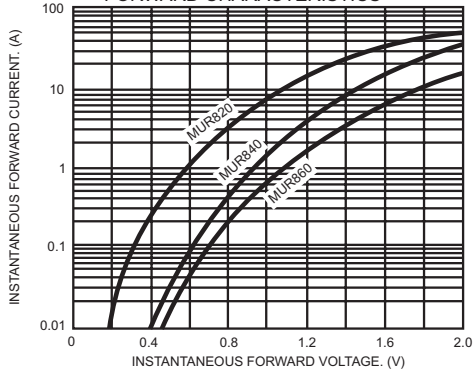

FIG.4- TYPICAL REVERSE CHARACTERISTICS

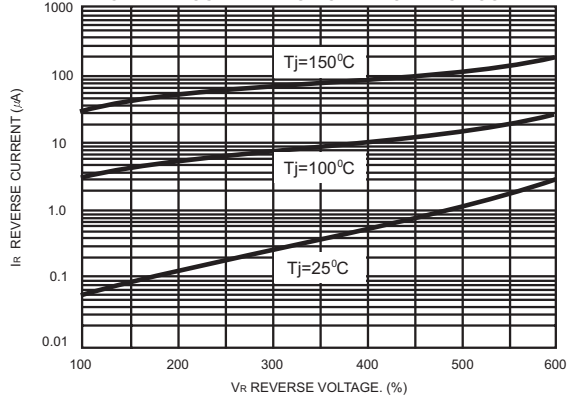

FIG.5- TYPICAL JUNCTION CAPACITANCE PER LEG

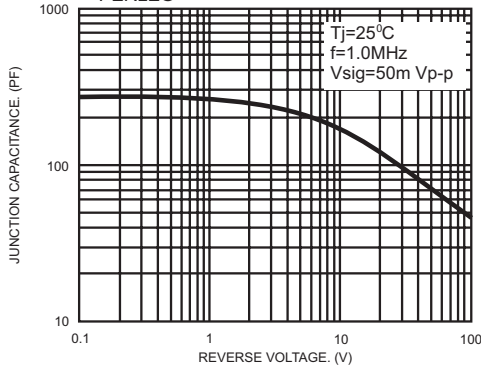
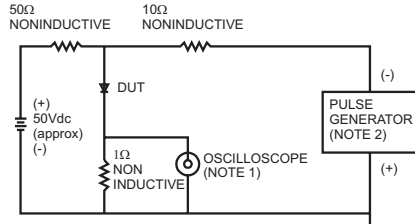

FIG.6- REVERSE RECOVERY TIME CHARACTERISTIC AND TEST CIRCUIT DIAGRAM



NOTES: 1. Rise Time=7ns max. Input Impedance= 1 megohm 22pf
2. Rise Time=10ns max. Source Impedance= 50 ohms

