

MDS75G

Glass Passivated Three Phase Rectifier Bridge

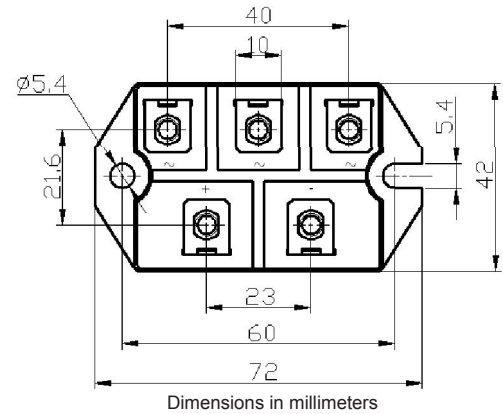
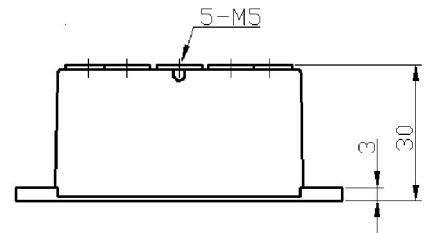
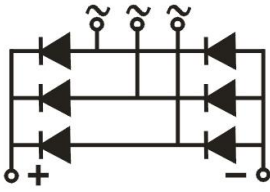

Applications

- Three phase rectifiers for power supplies
- Rectifiers for DC motor field supplies
- Battery charger rectifiers
- Input rectifiers for variable frequency drives

Features

- Three phase bridge rectifier
- Blocking voltage: 1200 to 1800V
- Heat transfer through aluminum oxide
- DBC ceramic isolated metal baseplate
- Glass passivated chip
- UL recognized applied for file no. E304417

Module Type

TYPE	VRRM	VRSM
MDS75G-12	1200V	1300V
MDS75G-16	1600V	1700V
MDS75G-18	1800V	1900V

Maximum Ratings

Symbol	Conditions	Values	Units
ID	Three phase, full wave Tc=100°C	75	A
IFSM	t=10mS Tvj =45°C	750	A
i ² t	t=10mS Tvj =45°C	2800	A ² s
Visol	a.c.50HZ;r.m.s.;1min	3000	V
Tvj		-40 to +150	°C
Tstg		-40 to +125	°C
Mt	To terminals(M5)	3±15%	Nm
Ms	To heatsink(M5)	3±15%	Nm
Weight	Module (Approximately)	130	g

Thermal Characteristics

Symbol	Conditions	Values	Units
Rth(j-c)	Module	0.20	°C/W

Electrical Characteristics

Symbol	Conditions	Values			Units
		Min.	Typ.	Max.	
VFM	T=25°C IF =75A	—	1.30	1.55	V
IRD	Tvj=25°C VRD=VRRM	—	—	10	µA
	Tvj=150°C VRD=VRRM	—	—	5	mA

MDS75G

Performance Curves

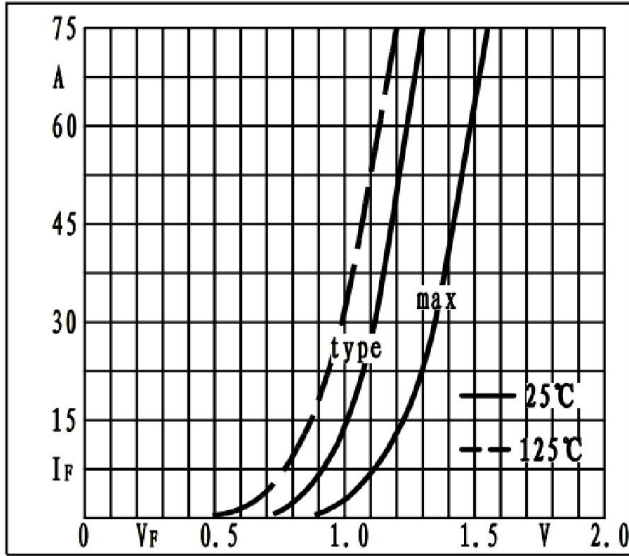

Fig1. Forward characteristics

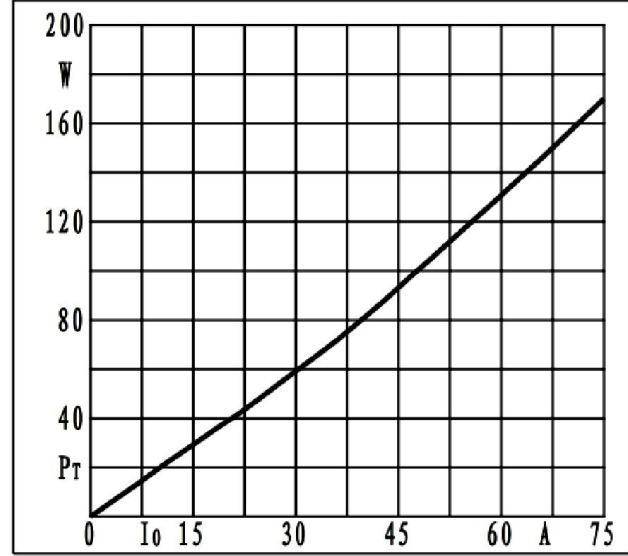

Fig2. Power dissipation

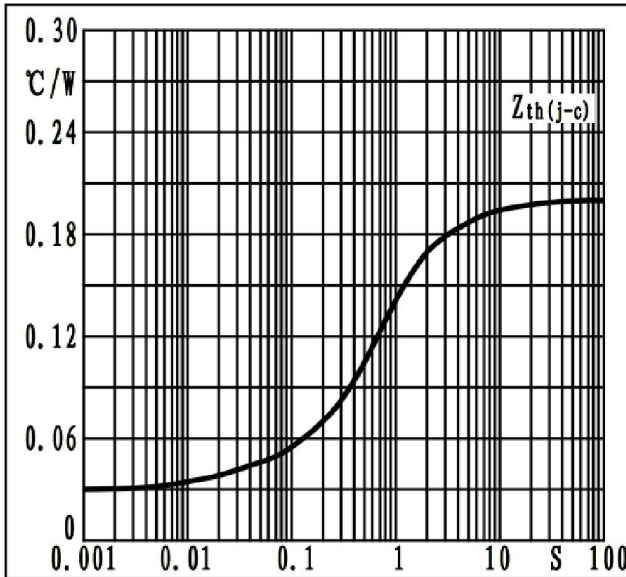

Fig3. Transient thermal impedance

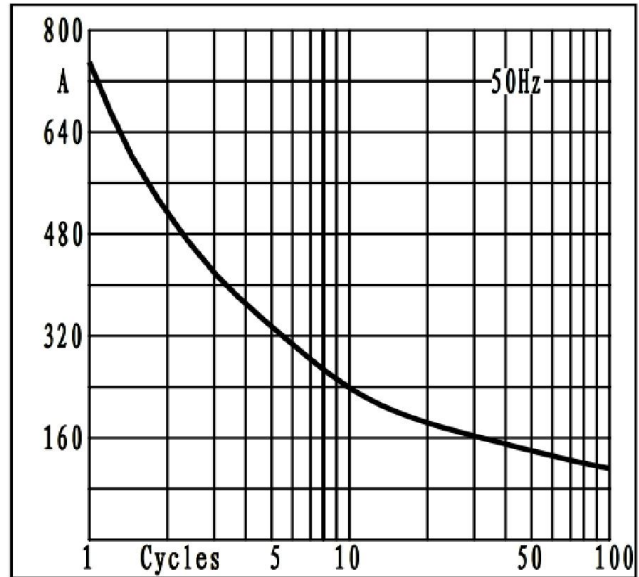

Fig4. Max non-repetitive forward surge current

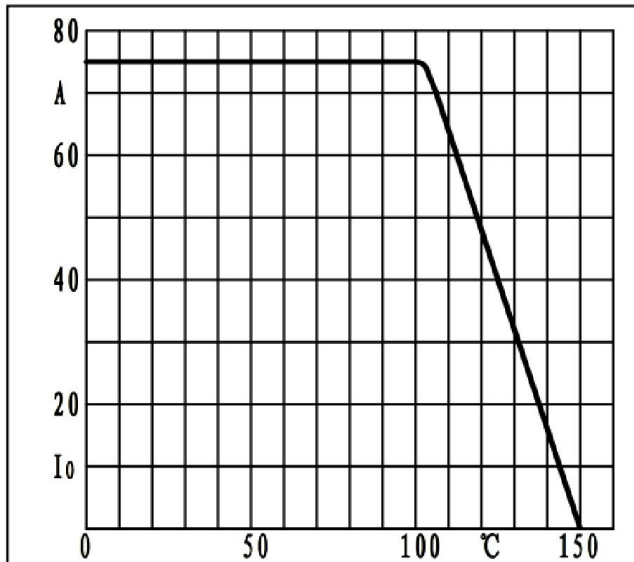

Fig5. Forward current derating curve