



DONGGUAN NANJING ELECTRONICS LTD.,

## TO-92 Plastic-Encapsulate Transistors

### S8550 TRANSISTOR (PNP)

#### FEATURE

- Excellent  $h_{FE}$  Linearity

#### MAXIMUM RATINGS ( $T_a=25^\circ\text{C}$ unless otherwise noted)

Symbol	Parameter	Value	Unit
$V_{CBO}$	Collector-Base Voltage	-40	V
$V_{CEO}$	Collector-Emitter Voltage	-25	V
$V_{EBO}$	Emitter-Base Voltage	-5	V
$I_C$	Collector Current -Continuous	-500	mA
$P_C$	Collector Dissipation	625	mW
$T_J$	Junction Temperature	150	$^\circ\text{C}$
$T_{stg}$	Junction and Storage Temperature	-55-150	$^\circ\text{C}$

#### TO-92

1. EMITTER
2. BASE
3. COLLECTOR

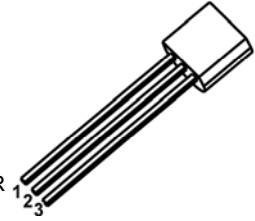

#### ELECTRICAL CHARACTERISTICS ( $T_a=25^\circ\text{C}$ unless otherwise specified)

Parameter	Symbol	Test conditions	Min	Typ	Max	Unit
Collector-base breakdown voltage	$V_{(BR)CBO}$	$I_C = -100\mu\text{A}$ , $I_E = 0$	-40			V
Collector-emitter breakdown voltage	$V_{(BR)CEO}$	$I_C = -1\text{mA}$ , $I_B = 0$	-25			V
Emitter-base breakdown voltage	$V_{(BR)EBO}$	$I_E = -100\mu\text{A}$ , $I_C = 0$	-5			V
Collector cut-off current	$I_{CBO}$	$V_{CB} = -40\text{V}$ , $I_E = 0$			-0.1	$\mu\text{A}$
Collector cut-off current	$I_{CEO}$	$V_{CE} = -20\text{V}$ , $I_B = 0$			-0.1	$\mu\text{A}$
Emitter cut-off current	$I_{EBO}$	$V_{EB} = -3\text{V}$ , $I_C = 0$			-0.1	$\mu\text{A}$
DC current gain	$h_{FE(1)}$	$V_{CE} = -1\text{V}$ , $I_C = -50\text{mA}$	85		400	
	$h_{FE(2)}$	$V_{CE} = -1\text{V}$ , $I_C = -500\text{mA}$	50			
Collector-emitter saturation voltage	$V_{CE(sat)}$	$I_C = -500\text{mA}$ , $I_B = -50\text{mA}$			-0.6	V
Base-emitter saturation voltage	$V_{BE(sat)}$	$I_C = -500\text{mA}$ , $I_B = -50\text{mA}$			-1.2	V
Transition frequency	$f_T$	$V_{CE} = -6\text{V}$ , $I_C = -20\text{mA}$ , $f = 30\text{MHz}$	150			MHz

#### CLASSIFICATION OF $h_{FE(1)}$

Rank	B	C	D	D3
Range	85-160	120-200	160- 300	300- 400

# Typical Characteristics

# S8550

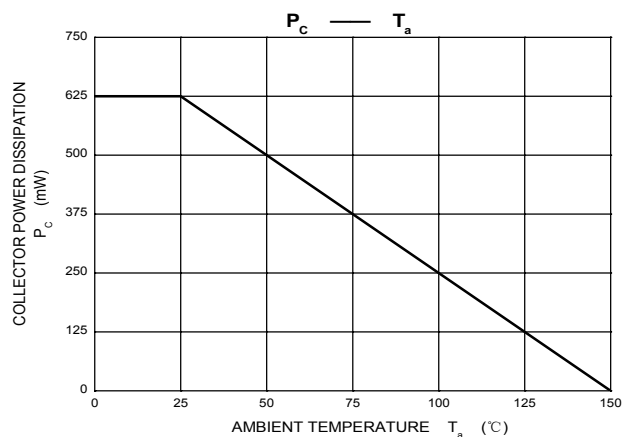
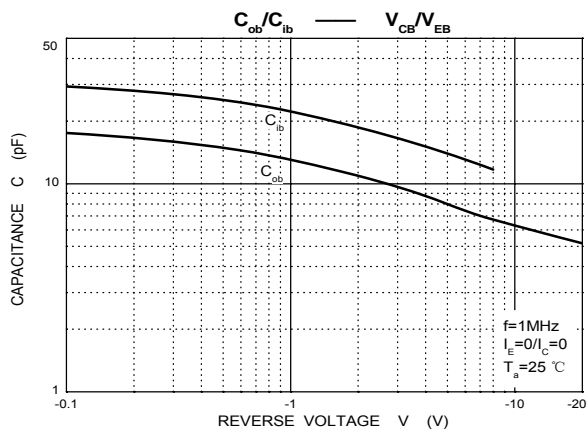
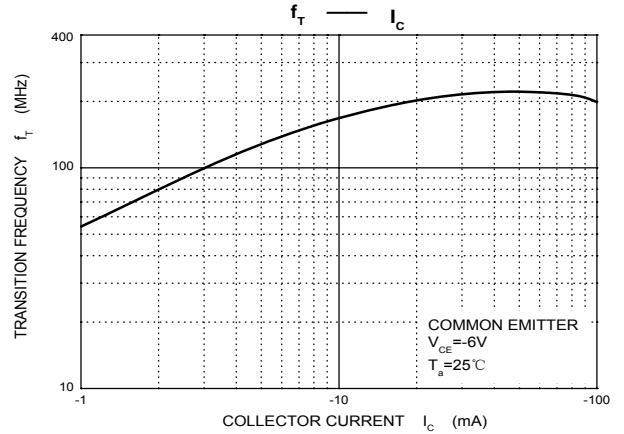
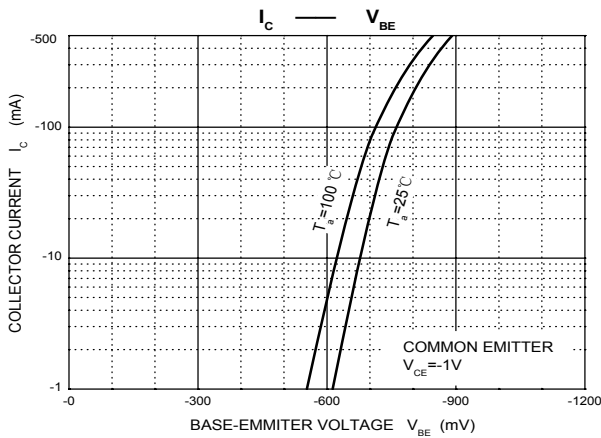
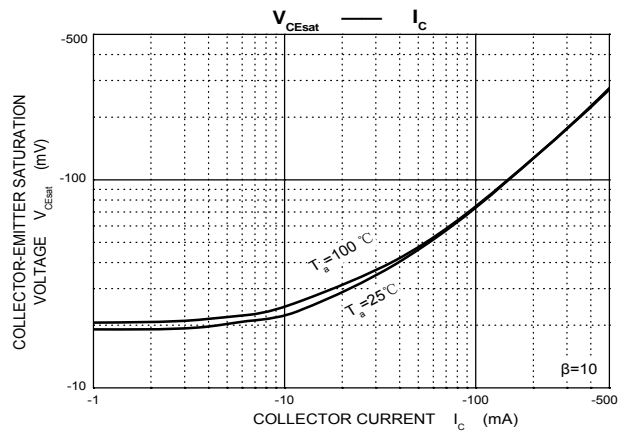
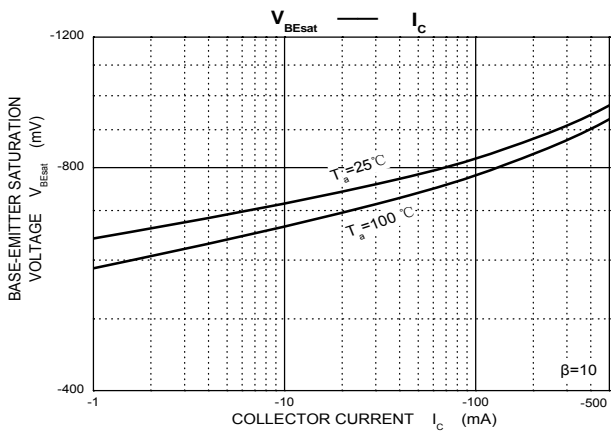
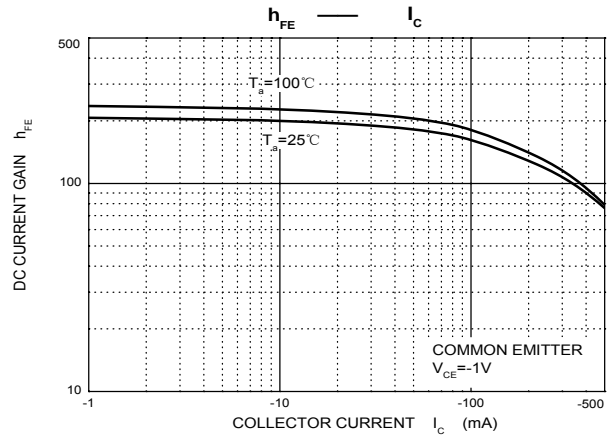
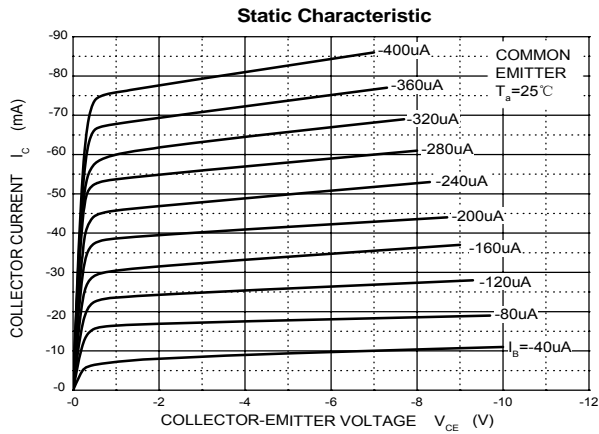

## TO-92 Package Outline Dimensions

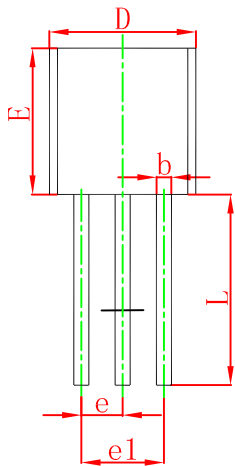
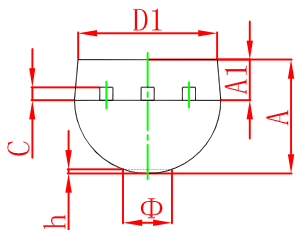

Symbol	Dimensions In Millimeters		Dimensions In Inches	
	Min	Max	Min	Max
A	3.300	3.700	0.130	0.146
A1	1.100	1.400	0.043	0.055
b	0.380	0.550	0.015	0.022
c	0.360	0.510	0.014	0.020
D	4.300	4.700	0.169	0.185
D1	3.430		0.135	
E	4.300	4.700	0.169	0.185
e	1.270 TYP		0.050 TYP	
e1	2.440	2.640	0.096	0.104
L	14.100	14.500	0.555	0.571
Φ		1.600		0.063
h	0.000	0.380	0.000	0.015

## TO-92 Suggested Pad Layout

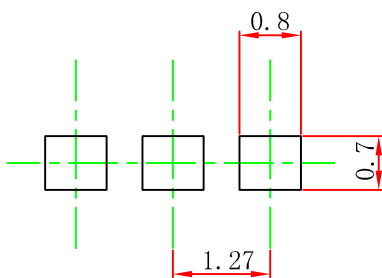

### Note:

1. Controlling dimension: in millimeters.
2. General tolerance:  $\pm 0.05$  mm.
3. The pad layout is for reference purposes only.

TO-92 PACKAGE TAPEING DIMENSION

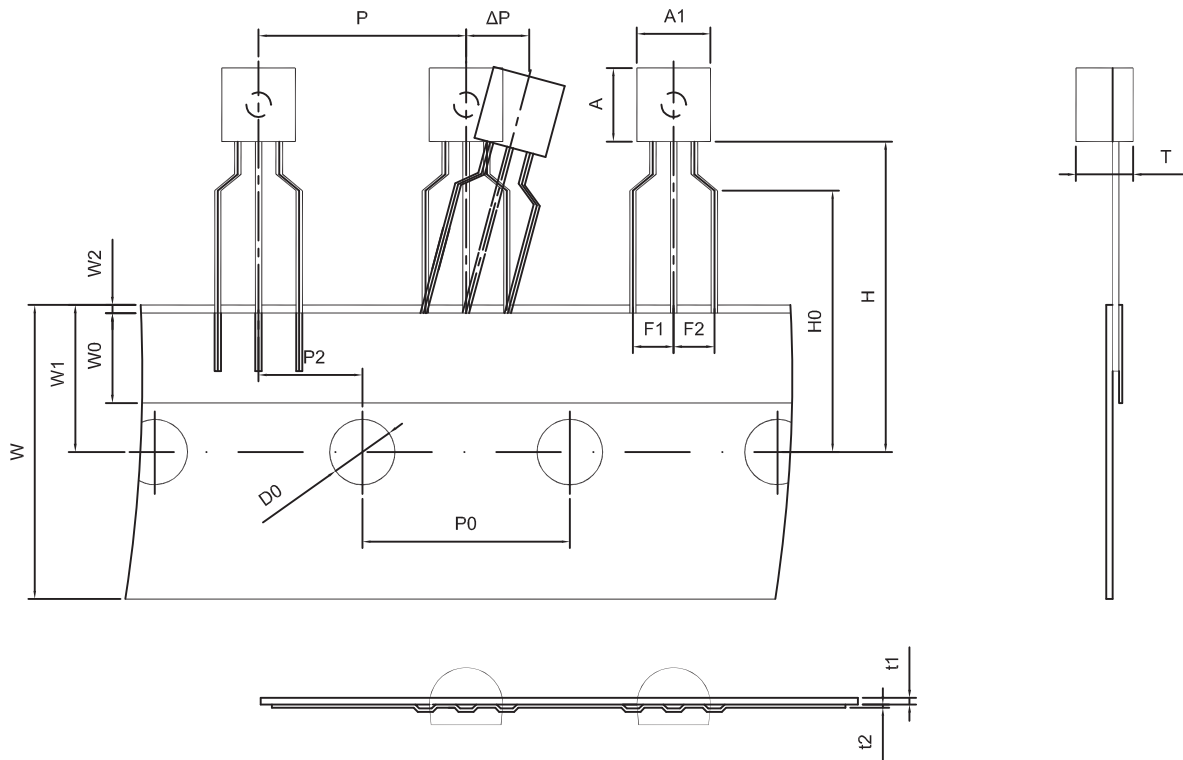

Dimiensions are in millimeter								
A1	A	T	P	P0	P2	F1	F2	W
4.5±0.2	4.5±0.2	3.5±0.2	12.7±0.3	12.7±0.2	6.35±0.3	2.5±0.3	2.5±0.3	18.0+1.0/-0.5
W0	W1	W2	H	H0	D0	t1	t2	ΔP
6.0±0.5	9.0±0.5	1.0 MAX.	19.0±1.0	16.0±0.5	4.0±0.2	0.4±0.05	0.2±0.05	0 ± 1.0

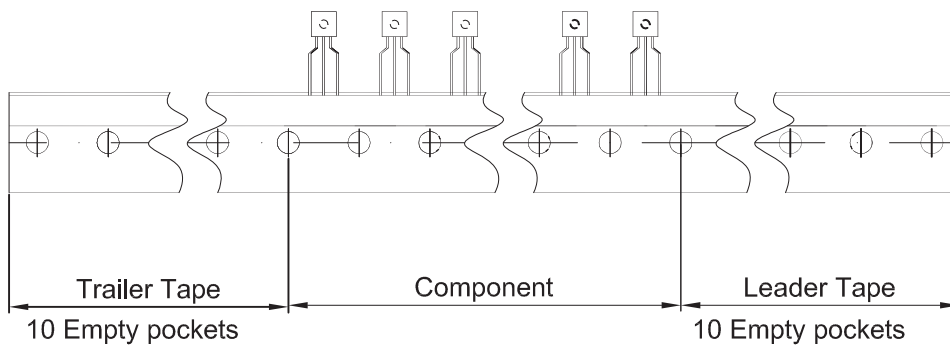

Package	Box	Box Size(mm)	Carton	Carton Size(mm)
TO-92	2000 pcs	333×162×43	20,000 pcs	350×340×250