



DONGGUAN NANJING ELECTRONICS LTD.,

Silicon PNP epitaxial planer transistor

2SB766

FEATURES

- Large collector power dissipation P_C .
- Mini Power type package, allowing downsizing of the equipment and automatic insertion through the tape packing and the magazine packing.

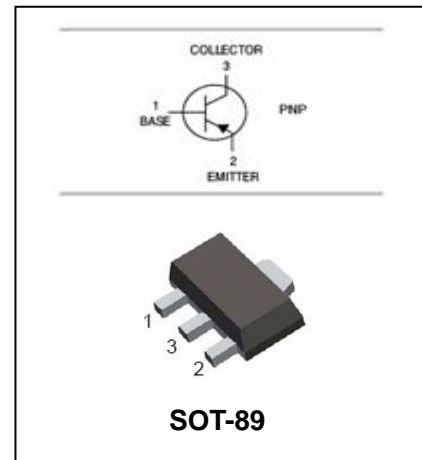

ORDERING INFORMATION

Type No.	Marking	Package Code
2SB766	AQ/AR/AS	SOT-89

MAXIMUM RATING @ $T_a=25^\circ\text{C}$ unless otherwise specified

Symbol	Parameter	Value	Unit
V_{CBO}	Collector-Base voltage	-30	V
V_{CEO}	Collector-Emitter voltage	-25	V
V_{EBO}	Emitter-Base voltage	-5	V
I_C	Collector current	-1	A
I_{CP}	Peak collector current	-1.5	A
P_C	Collector power dissipation	500	mW
T_j, T_{stg}	Junction and storage temperature	-55 to +150	$^\circ\text{C}$

Silicon PNP epitaxial planer transistor

2SB766

ELECTRICAL CHARACTERISTICS @ Ta=25°C unless otherwise specified

Parameter	Symbol	Test conditions	MIN		MAX	UNIT
Collector-base breakdown voltage	$V_{(BR)CBO}$	$I_C = -10\mu A$ $I_E = 0$	-30			V
Collector-emitter breakdown voltage	$V_{(BR)CEO}$	$I_C = -2mA$ $I_B = 0$	-25			V
Emitter-base breakdown voltage	$V_{(BR)EBO}$	$I_E = -10\mu A$ $I_C = 0$	-5			V
Collector cut-off current	I_{CBO}	$V_{CB} = -20V$ $I_E = 0$			-0.1	μA
DC current gain	h_{FE}	$V_{CE} = -10V$ $I_C = -500mA$	85		340	
		$V_{CE} = -5V$ $I_C = -1A$	50			
Collector-emitter saturation voltage	$V_{CE(sat)}$	$I_C = -500mA$ $I_B = -50mA$		-0.2	-0.4	V
Base- emitter saturation voltage	$V_{BE(sat)}$	$I_C = -500mA$ $I_B = -50mA$		-0.85	-1.2	V
Transition frequency	f_T	$V_{CE} = -10V, I_C = -50mA,$ $f = 200MHz$		200		MHz
Collector Output Capacitance	C_{obo}	$V_{CB} = -10V$ $f = 1.0MHz$ $I_E = 0$	-	20	30	pF

CLASSIFICATION H_{FE}

Rank	Q	R	S
Range	85-170	120-240	170-340
Marking	AQ	AR	AS

Silicon PNP epitaxial planer transistor

2SB766

TYPICAL CHARACTERISTICS @ $T_a=25^\circ\text{C}$ unless otherwise specified

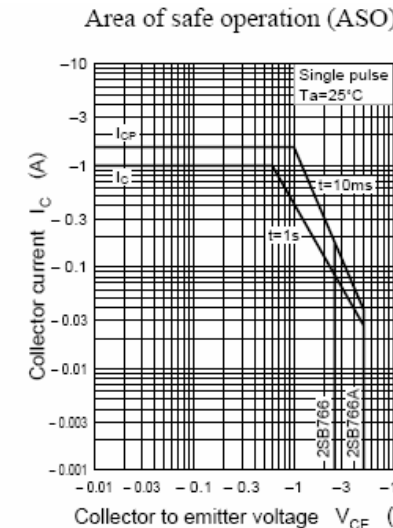
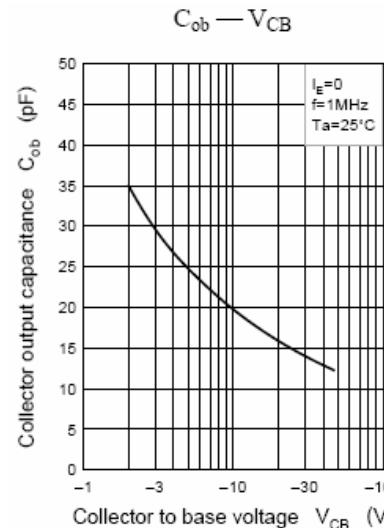
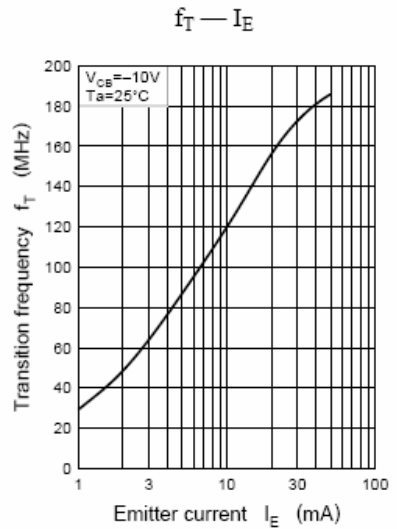
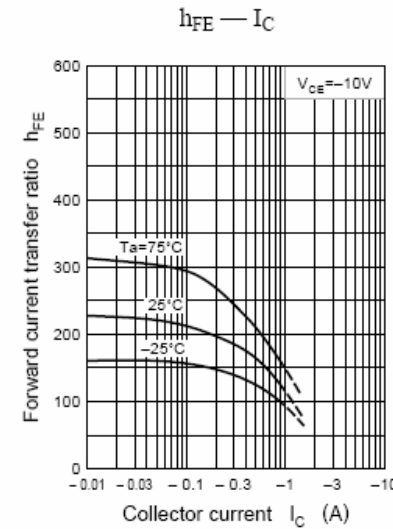
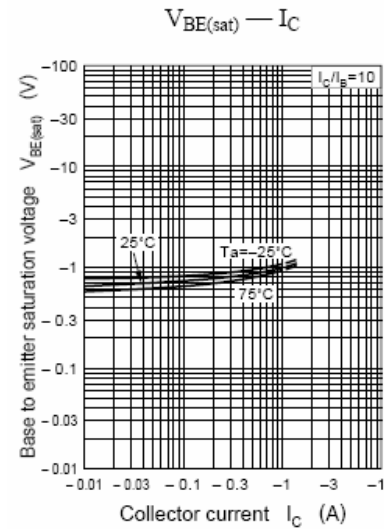
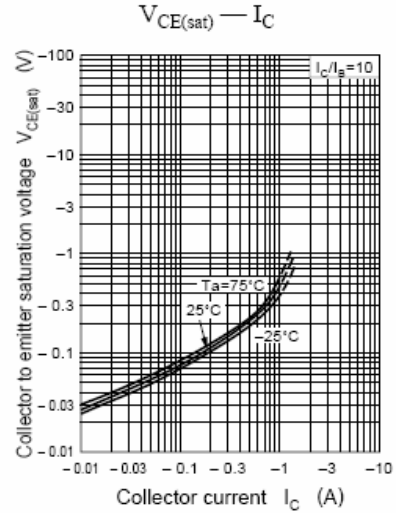
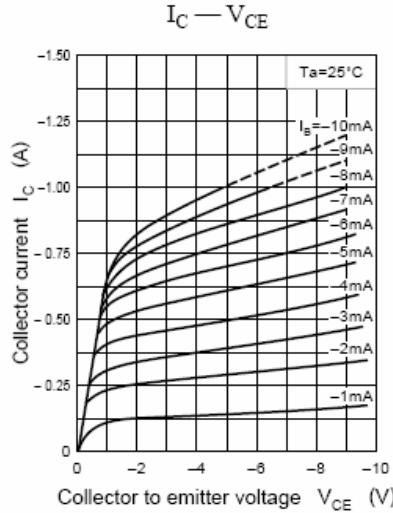
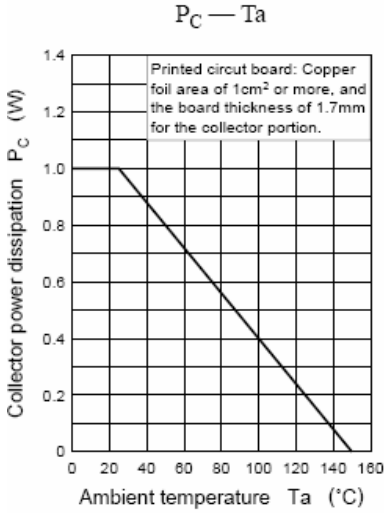

Silicon PNP epitaxial planer transistor

2SB766

PACKAGE OUTLINE

Plastic surface mounted package

SOT-89

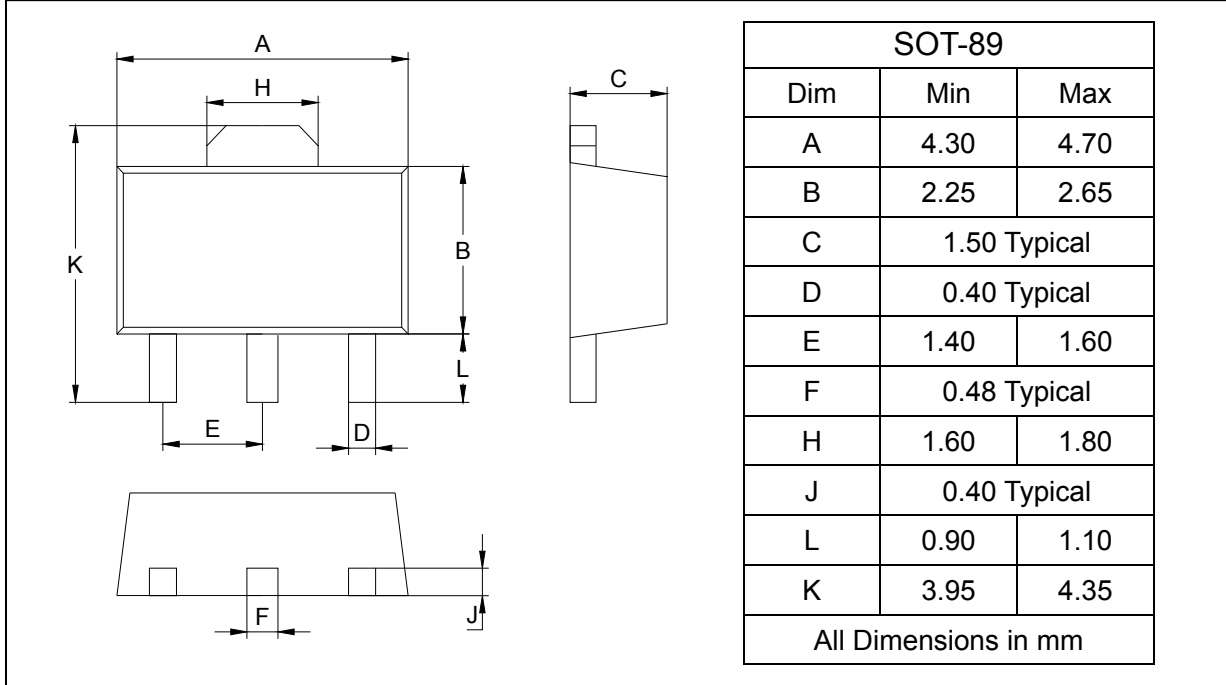

SOLDERING FOOTPRINT

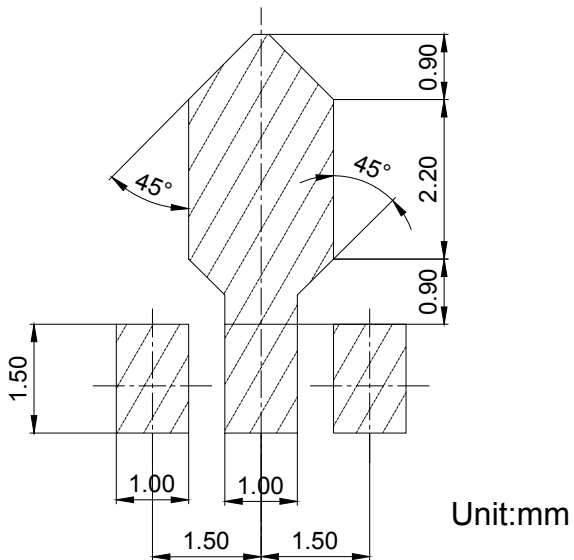

PACKAGE INFORMATION

Device	Package	Shipping
2SB766	SOT-89	1000/Tape&Reel