



# DONGGUAN NANJING ELECTRONICS LTD.,

## TO-92 Plastic-Encapsulate Transistors

### 2SA950 TRANSISTOR (PNP)

#### FEATURES

- 1W Output Applications
- Complementary to 2SC2120

#### MAXIMUM RATINGS ( $T_a=25\text{ }^\circ\text{C}$ unless otherwise noted)

Symbol	Parameter	Value	Unit
$V_{CB0}$	Collector-Base Voltage	-35	V
$V_{CE0}$	Collector-Emitter Voltage	-30	V
$V_{EB0}$	Emitter-Base Voltage	-5	V
$I_C$	Collector Current -Continuous	-0.8	A
$P_C$	Collector Power Dissipation	0.6	W
$T_j$	Junction Temperature	150	$^\circ\text{C}$
$T_{stg}$	Storage Temperature	-55 to +150	$^\circ\text{C}$

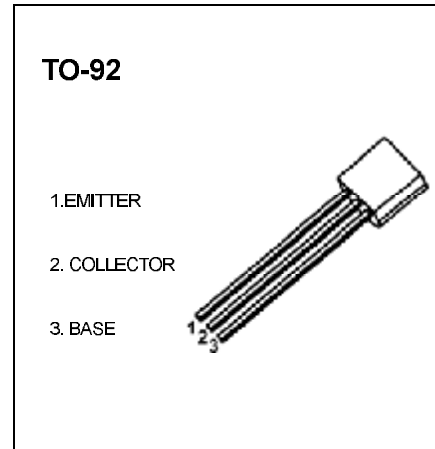

#### ELECTRICAL CHARACTERISTICS ( $T_a=25\text{ }^\circ\text{C}$ unless otherwise specified)

Parameter	Symbol	Test conditions	Min	Typ	Max	Unit
Collector-base breakdown voltage	$V_{(BR)CBO}$	$I_C = -0.1\text{mA}$ , $I_E = 0$	-35			V
Collector-emitter breakdown voltage	$V_{(BR)CEO}$	$I_C = -10\text{mA}$ , $I_B = 0$	-30			V
Emitter-base breakdown voltage	$V_{(BR)EBO}$	$I_E = -0.1\text{mA}$ , $I_C = 0$	-5			V
Collector cut-off current	$I_{CBO}$	$V_{CB} = -35\text{V}$ , $I_E = 0$			-0.1	$\mu\text{A}$
Emitter cut-off current	$I_{EBO}$	$V_{EB} = -5\text{V}$ , $I_C = 0$			-0.1	$\mu\text{A}$
DC current gain	$h_{FE(1)}$	$V_{CE} = -1\text{V}$ , $I_C = -100\text{mA}$	100		320	
	$h_{FE(2)}$	$V_{CE} = -1\text{V}$ , $I_C = -700\text{mA}$	35			
Collector-emitter saturation voltage	$V_{CE(sat)}$	$I_C = -500\text{mA}$ , $I_B = -20\text{mA}$			-0.7	V
Emitter-base voltage	$V_{BE}$	$V_{CE} = -1\text{V}$ , $I_C = -10\text{mA}$	-0.5		-0.8	V
Collector Output Capacitance	$C_{ob}$	$V_{CB} = -10\text{V}$ , $I_E = 0$ $f = 1\text{MHz}$		19		pF
Transition frequency	$f_T$	$V_{CE} = -5\text{V}$ , $I_C = -10\text{mA}$		120		MHz

#### CLASSIFICATION OF $h_{FE(1)}$

Rank	O	Y
Range	100-200	160-320

# Typical Characteristics

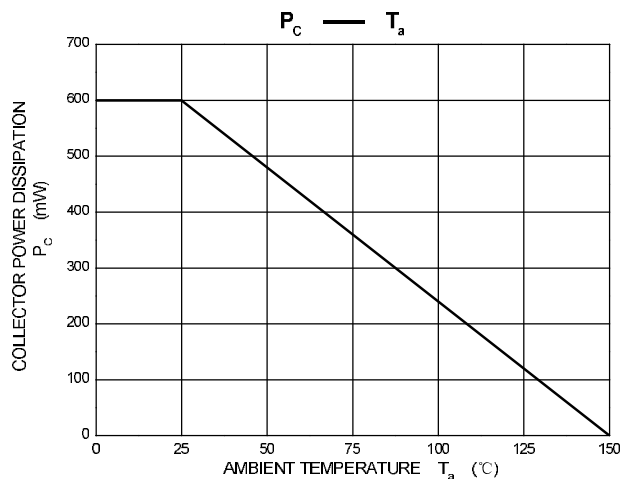
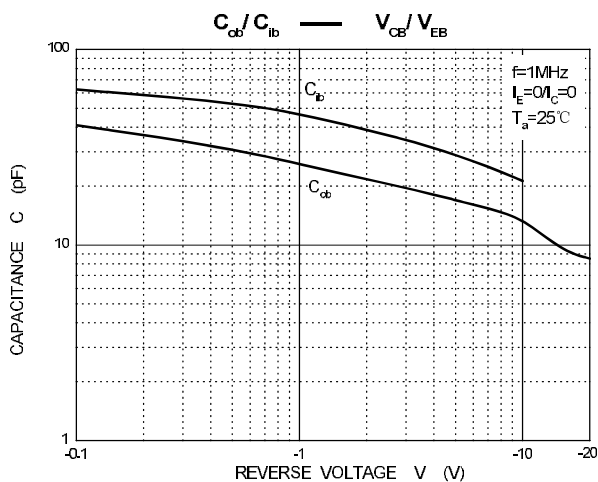
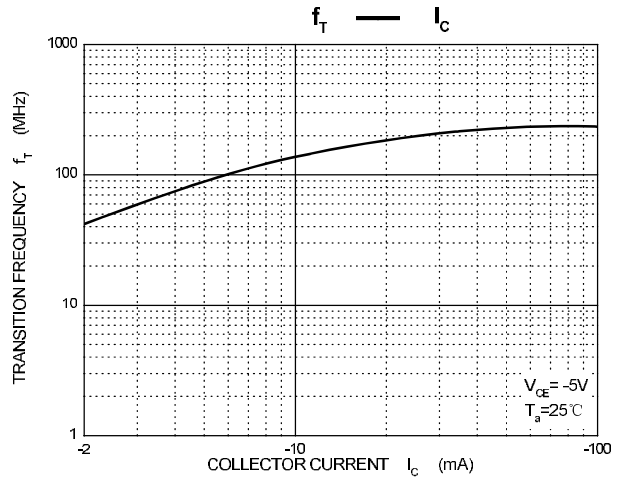
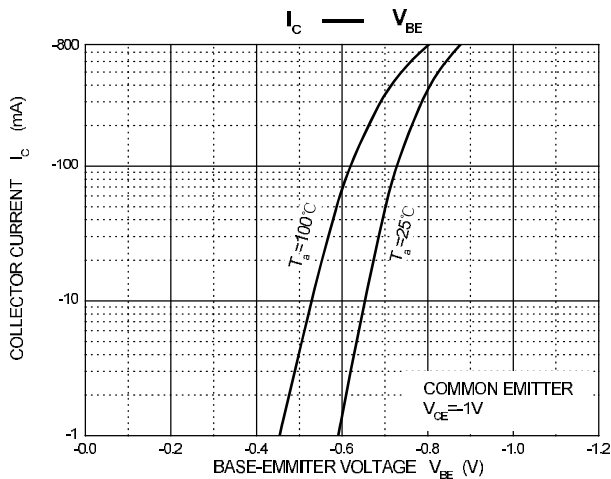
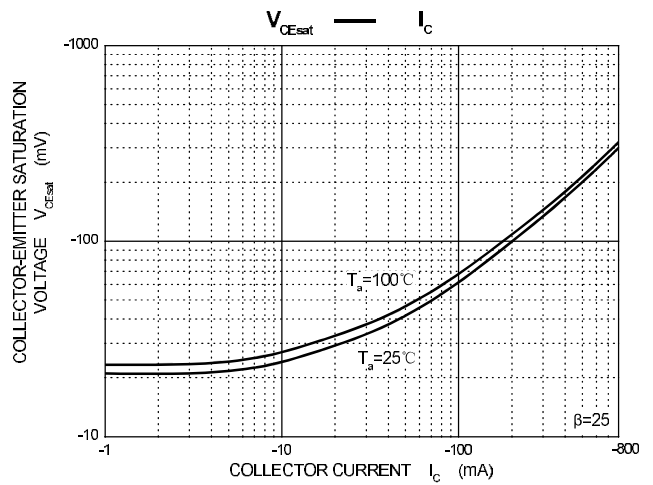
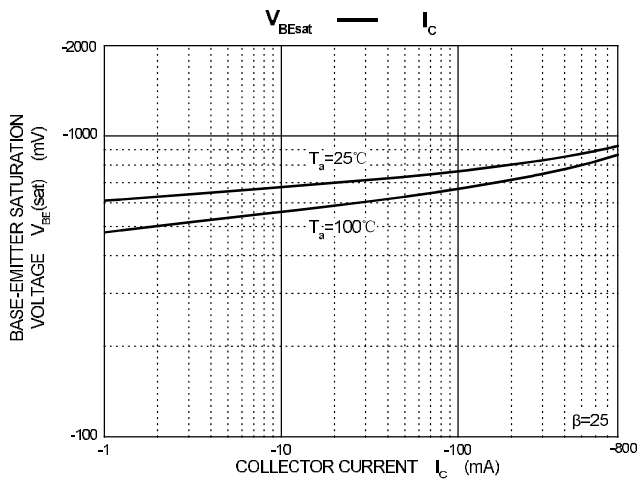
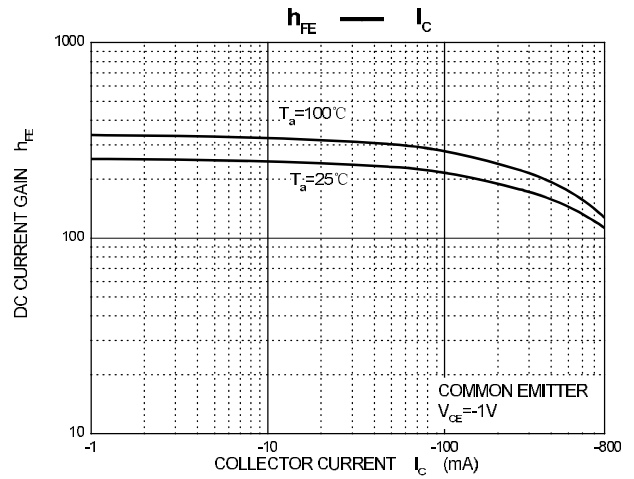
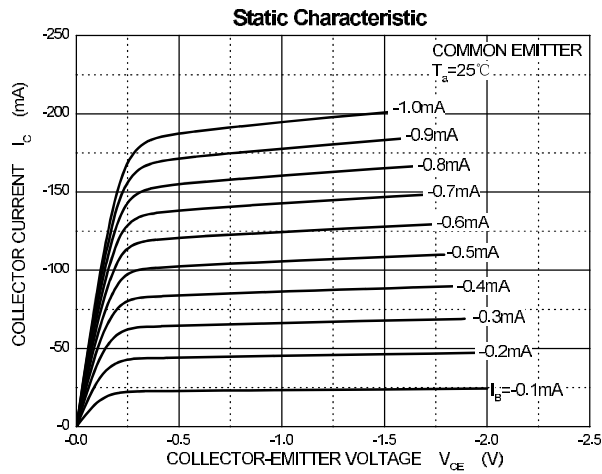

## TO-92 Package Outline Dimensions

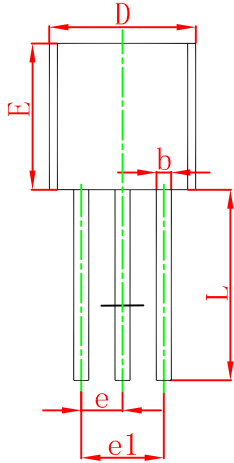
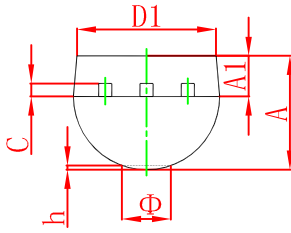

Symbol	Dimensions In Millimeters		Dimensions In Inches	
	Min	Max	Min	Max
A	3.300	3.700	0.130	0.146
A1	1.100	1.400	0.043	0.055
b	0.380	0.550	0.015	0.022
c	0.360	0.510	0.014	0.020
D	4.300	4.700	0.169	0.185
D1	3.430		0.135	
E	4.300	4.700	0.169	0.185
e	1.270 TYP		0.050 TYP	
e1	2.440	2.640	0.096	0.104
L	14.100	14.500	0.555	0.571
Φ		1.600		0.063
h	0.000	0.380	0.000	0.015

## TO-92 Suggested Pad Layout

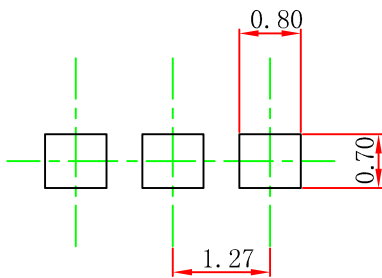

### Note:

1. Controlling dimension: in millimeters.
2. General tolerance:  $\pm 0.05\text{mm}$ .
3. The pad layout is for reference purposes only.

TO-92 PACKAGE TAPEING DIMENSION

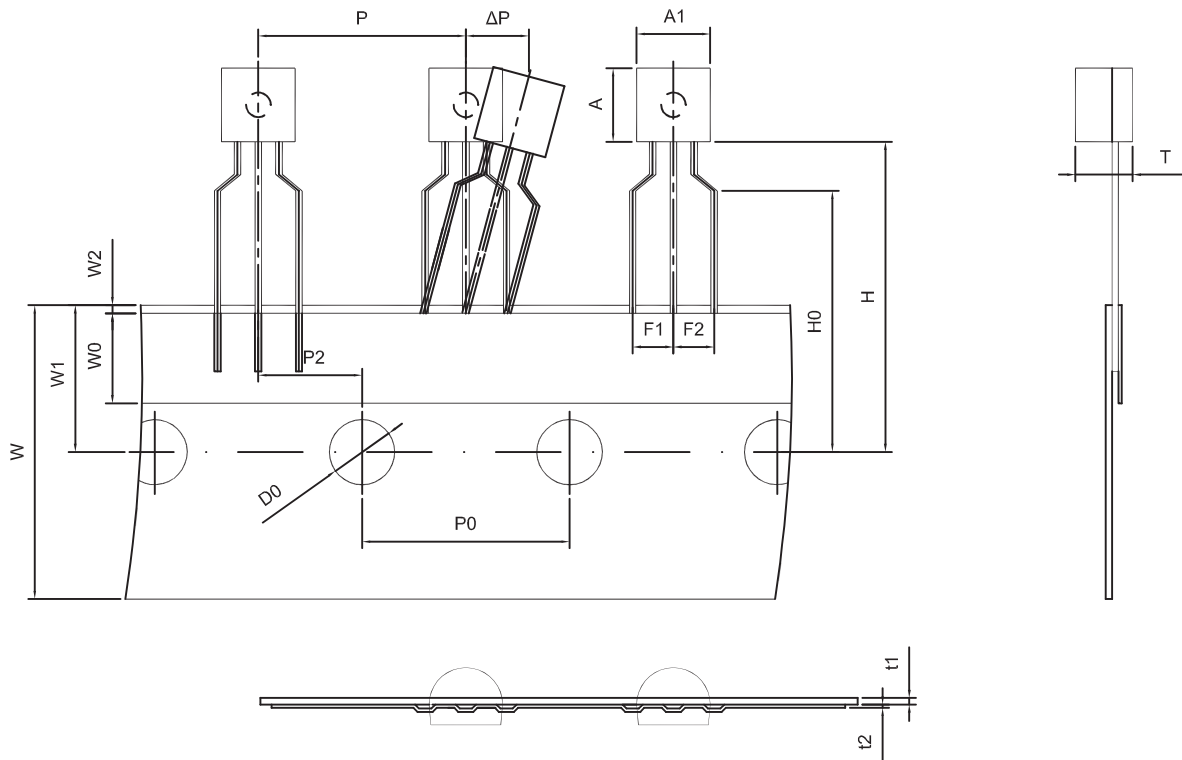

Dimiensions are in millimeter

A1	A	T	P	P0	P2	F1	F2	W
4.5	4.5	3.5	12.7	12.7	6.35	2.5	2.5	18.0
W0	W1	W2	H	H0	D0	t1	t2	ΔP
6.0	9.0	1.0 MAX.	19.0	16.0	4.0	0.4	0.2	0

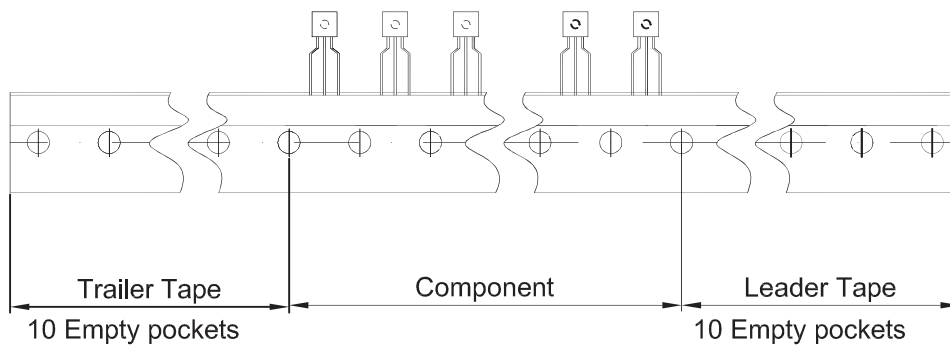

Package	Box	Box Size(mm)	Carton	Carton Size(mm)
TO-92	2000 pcs	333×162×43	20,000 pcs	350×340×250