



**DONGGUAN NANJING ELECTRONICS LTD.,**  
**TO-92 Plastic-Encapsulate Transistors**

**2SB1322A** TRANSISTOR (PNP)

**FEATURES**

- Allowing Supply with The Radial Taping

TO - 92

1. EMITTER
2. COLLECTOR
3. BASE

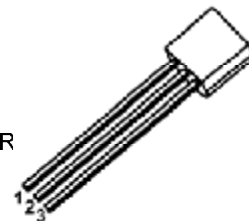

**MAXIMUM RATINGS (T<sub>a</sub>=25°C unless otherwise noted)**

Symbol	Parameter	Value	Unit
V <sub>CBO</sub>	Collector-Base Voltage	-60	V
V <sub>CEO</sub>	Collector-Emitter Voltage	-50	V
V <sub>EBO</sub>	Emitter-Base Voltage	-5	V
I <sub>C</sub>	Collector Current	-1	A
P <sub>C</sub>	Collector Power Dissipation	625	mW
R <sub>θJA</sub>	Thermal Resistance From Junction To Ambient	200	°C/W
T <sub>j</sub>	Junction Temperature	150	°C
T <sub>stg</sub>	Storage Temperature	-55~+150	°C

**ELECTRICAL CHARACTERISTICS (T<sub>a</sub>=25°C unless otherwise specified)**

Parameter	Symbol	Test conditions	Min	Typ	Max	Unit
Collector-base breakdown voltage	V <sub>(BR)CBO</sub>	I <sub>C</sub> = -0.01mA, I <sub>E</sub> =0	-60			V
Collector-emitter breakdown voltage	V <sub>(BR)CEO</sub>	I <sub>C</sub> =-2mA, I <sub>B</sub> =0	-50			V
Emitter-base breakdown voltage	V <sub>(BR)EBO</sub>	I <sub>E</sub> =-0.01mA, I <sub>C</sub> =0	-5			V
Collector cut-off current	I <sub>CBO</sub>	V <sub>CB</sub> =-20V, I <sub>E</sub> =0			-0.1	μA
Emitter cut-off current	I <sub>EBO</sub>	V <sub>EB</sub> =-5V, I <sub>C</sub> =0			-0.1	μA
DC current gain	h <sub>FE(1)</sub>	V <sub>CE</sub> =-10V, I <sub>C</sub> =-0.5A	85		340	
	h <sub>FE(2)</sub>	V <sub>CE</sub> =-5V, I <sub>C</sub> =-1A	50			
Collector-emitter saturation voltage	V <sub>CE(sat)</sub>	I <sub>C</sub> =-0.5A, I <sub>B</sub> =-0.05A			-0.4	V
Base-emitter saturation voltage	V <sub>BE(sat)</sub>	I <sub>C</sub> =-0.5A, I <sub>B</sub> =-0.05A			-1.2	V
Collector output capacitance	C <sub>ob</sub>	V <sub>CB</sub> =-10V, I <sub>E</sub> =0, f=1MHz			30	pF
Transition frequency	f <sub>T</sub>	V <sub>CE</sub> =-10V, I <sub>C</sub> = -0.05A, f=200MHz		200		MHz

**CLASSIFICATION OF h<sub>FE(1)</sub>**

RANK	Q	R	S
RANGE	85-170	120-240	170-340

# Typical Characteristics

Static Characteristic

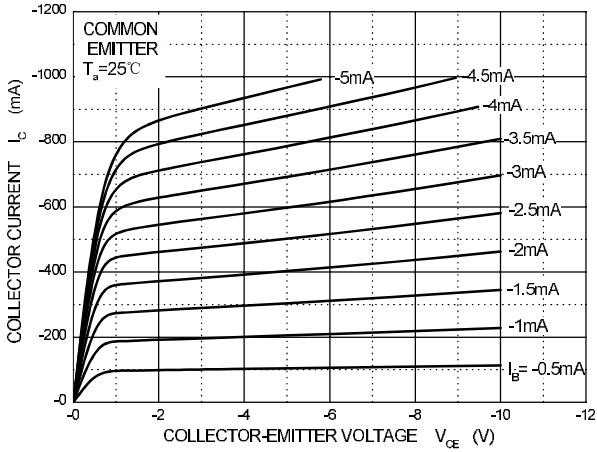

$h_{FE} - I_c$

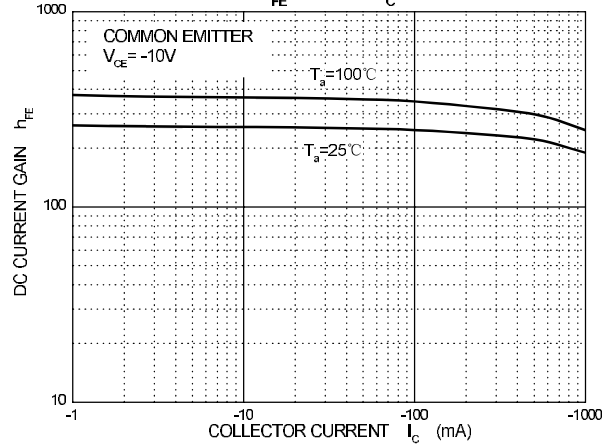

$V_{BEsat} - I_c$

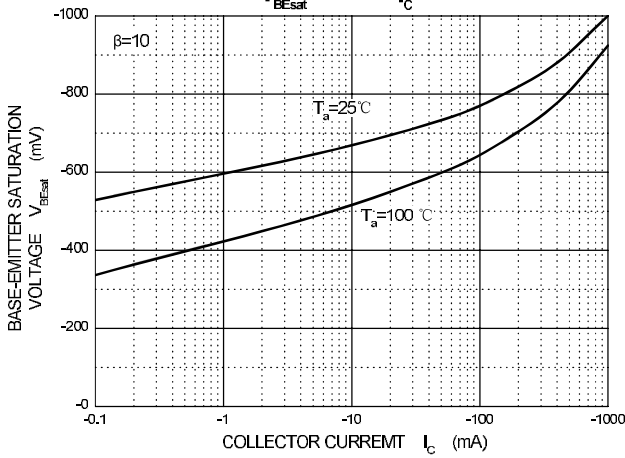

$V_{CEsat} - I_c$

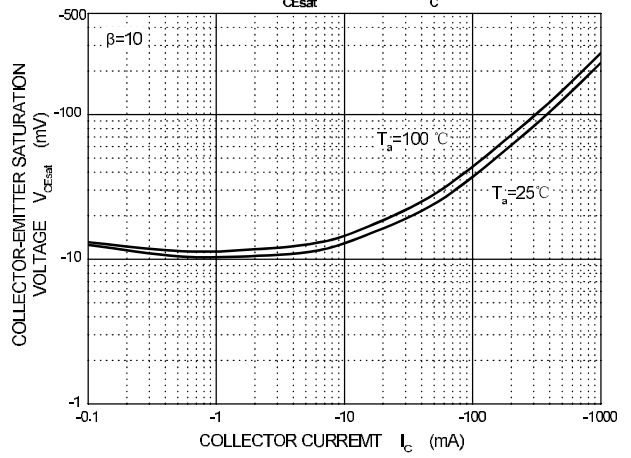

$I_c - V_{BE}$

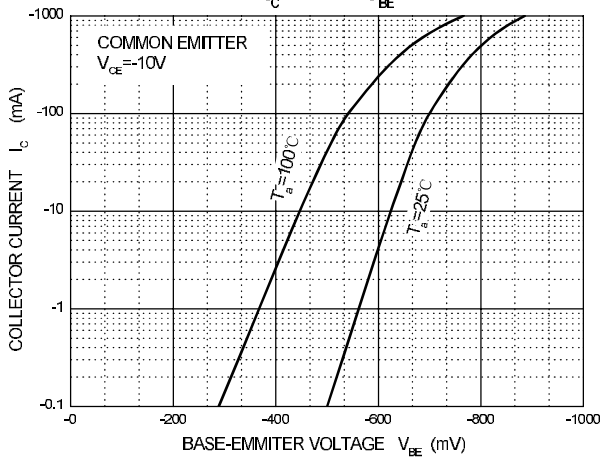

$f_T - I_c$

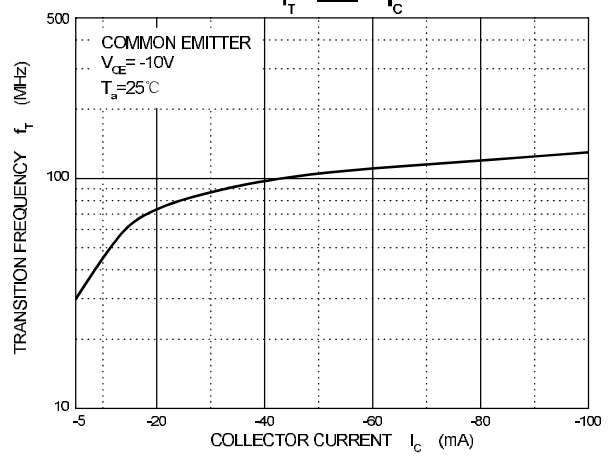

$C_{cb}/C_{ib} - V_{CB}/V_{EB}$

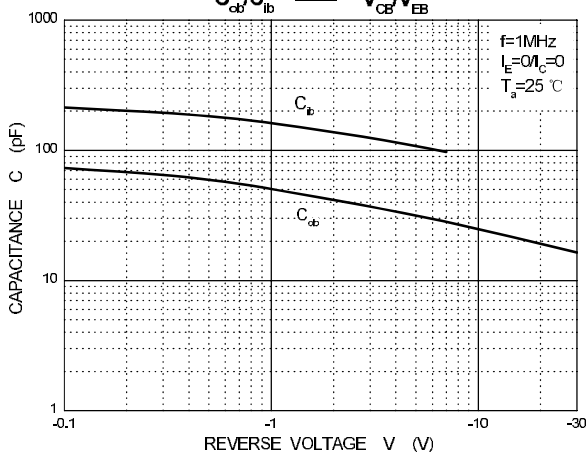

$P_c - T_a$

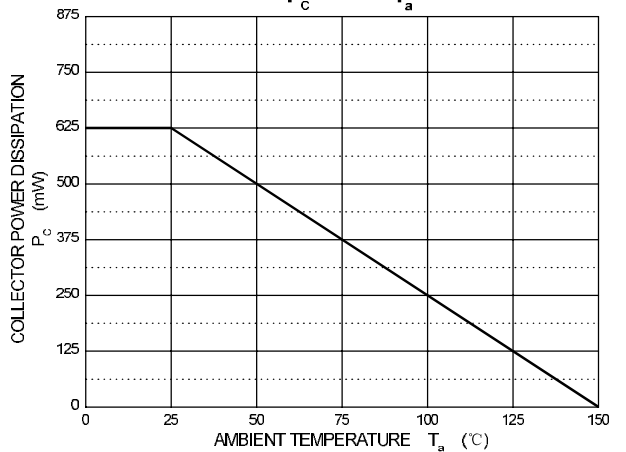

## TO-92 Package Outline Dimensions

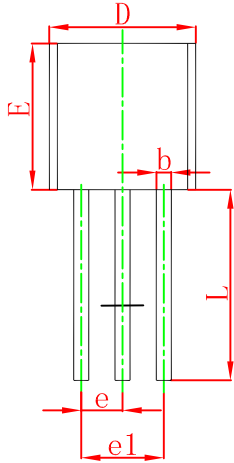
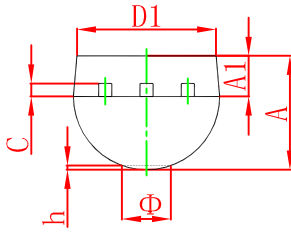

Symbol	Dimensions In Millimeters		Dimensions In Inches	
	Min	Max	Min	Max
A	3.300	3.700	0.130	0.146
A1	1.100	1.400	0.043	0.055
b	0.380	0.550	0.015	0.022
c	0.360	0.510	0.014	0.020
D	4.300	4.700	0.169	0.185
D1	3.430		0.135	
E	4.300	4.700	0.169	0.185
e	1.270 TYP		0.050 TYP	
e1	2.440	2.640	0.096	0.104
L	14.100	14.500	0.555	0.571
Φ		1.600		0.063
h	0.000	0.380	0.000	0.015

## TO-92 Suggested Pad Layout

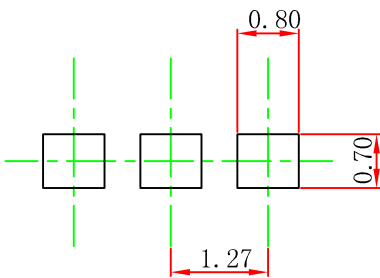

### Note:

1. Controlling dimension: in millimeters.
2. General tolerance:  $\pm 0.05$ mm.
3. The pad layout is for reference purposes only.

TO-92 PACKAGE TAPEING DIMENSION

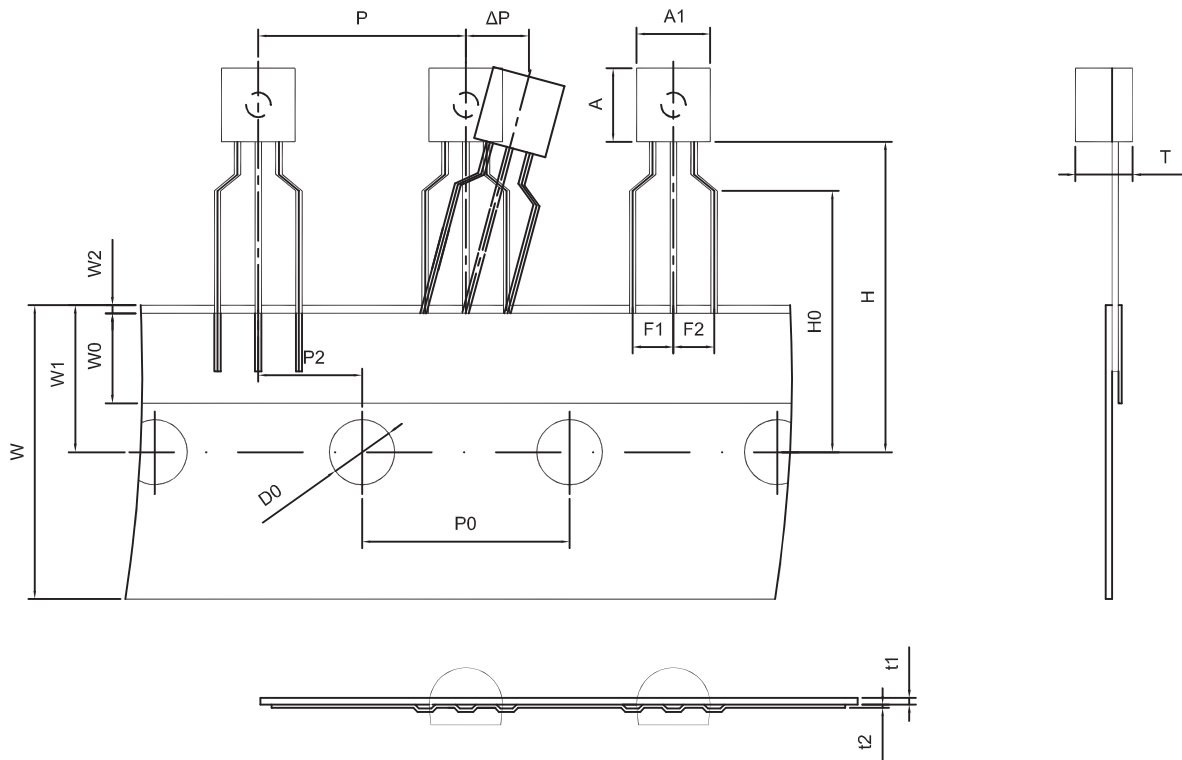

Dimiensions are in millimeter								
A1	A	T	P	P0	P2	F1	F2	W
4.5	4.5	3.5	12.7	12.7	6.35	2.5	2.5	18.0
W0	W1	W2	H	H0	D0	t1	t2	ΔP
6.0	9.0	1.0 MAX.	19.0	16.0	4.0	0.4	0.2	0

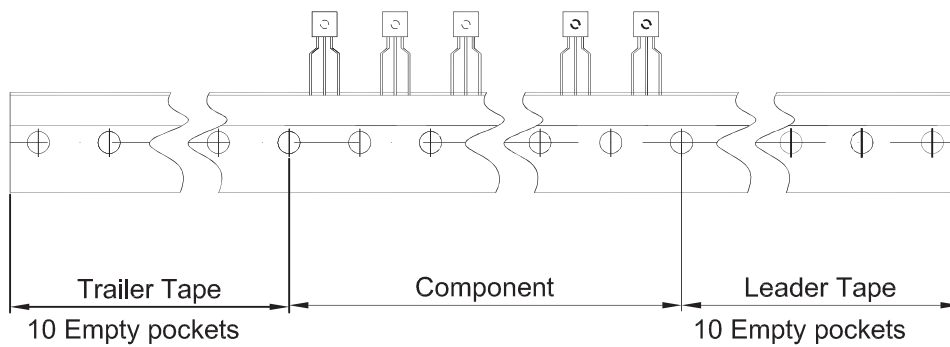

Package	Box	Box Size(mm)	Carton	Carton Size(mm)
TO-92	2000 pcs	333×162×43	20,000 pcs	350×340×250