



DONGGUAN NANJING ELECTRONICS LTD.,
TO-92 Plastic-Encapsulate Transistors

BC327/BC328 TRANSISTOR (PNP)

FEATURES

MAXIMUM RATINGS (T_a=25°C unless otherwise noted)

Symbol	Parameter	Value	Unit
V _{CBO}	Collector-Base Voltage	BC327	-50
		BC328	-30
V _{CEO}	Collector-Emitter Voltage	BC327	-45
		BC328	-25
V _{EBO}	Emitter-Base Voltage	-5	V
I _C	Collector Current -Continuous	-800	mA
P _C	Collector Power Dissipation	625	mW
T _j	Junction Temperature	150	°C
T _{stg}	Storage Temperature	-55-150	°C

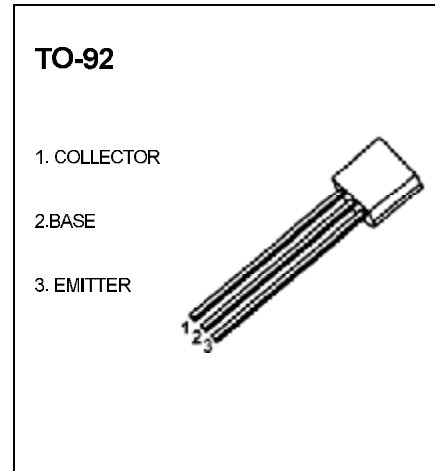

ELECTRICAL CHARACTERISTICS (T_a=25°C unless otherwise specified)

Parameter	Symbol	Test conditions	Min	Typ	Max	Unit
Collector-base breakdown voltage	V _{CBO}	I _C = -100uA, I _E =0	-50			V
			-30			
Collector-emitter breakdown voltage	V _{CEO}	I _C = -10mA, I _B =0	-45			V
			-25			
Emitter-base breakdown voltage	V _{EBO}	I _E = -10uA, I _C =0	-5			V
Collector cut-off current	I _{CBO}	V _{CB} = -45 V, I _E =0 V _{CB} = -25V, I _E =0			-0.1	uA
					-0.1	
Collector cut-off current	I _{CEO}	V _{CE} = -40 V, I _B =0 V _{CE} = -20 V, I _B =0			-0.2	uA
					-0.2	
Emitter cut-off current	I _{EBO}	V _{EB} = -4 V, I _C =0			-0.1	uA
DC current gain	h _{FE(1)}	V _{CE} =-1 V, I _C = -100mA	100		630	
	h _{FE(2)}	V _{CE} =-1 V, I _C = -300mA	40			
Collector-emitter saturation voltage	V _{CE(sat)}	I _C =-500mA, I _B = -50mA			-0.7	V
Base-emitter saturation voltage	V _{BE(sat)}	I _C = -500mA, I _B =-50mA			-1.2	V
Base-emitter voltage	V _{BE}	V _{CE} =-1 V, I _C = -300mA			-1.2	V
Transition frequency	f _T	V _{CE} = -5V, I _C = -10mA f = 100MHz	260			MHz
Collector Output Capacitance	C _{ob}	V _{CB} =-10V, I _E =0 f=1MHz		12		pF

CLASSIFICATION OF h_{FE}

Rank	16	25	40
Range	100-250	160-400	250-630

Typical Characteristics

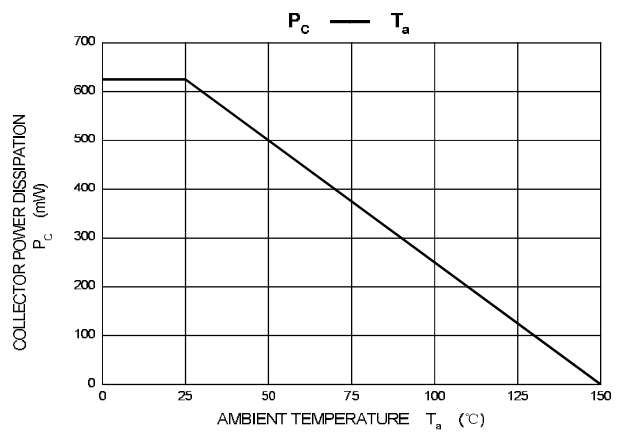
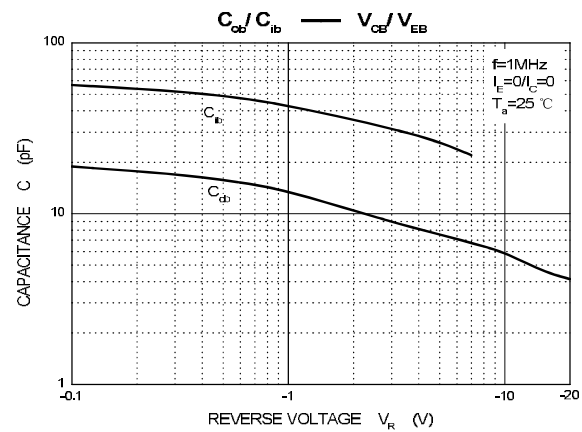
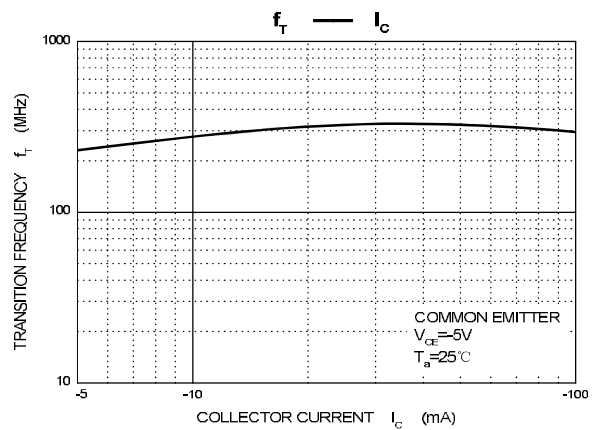
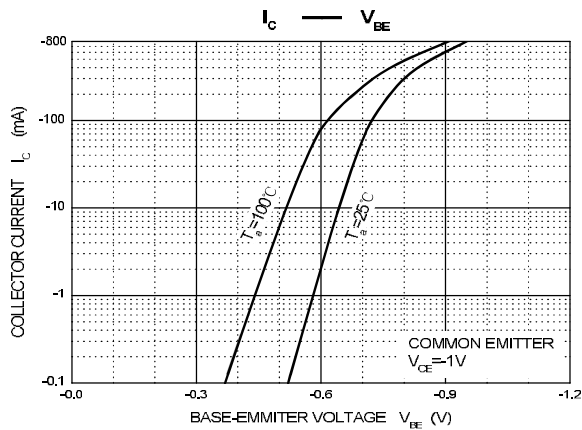
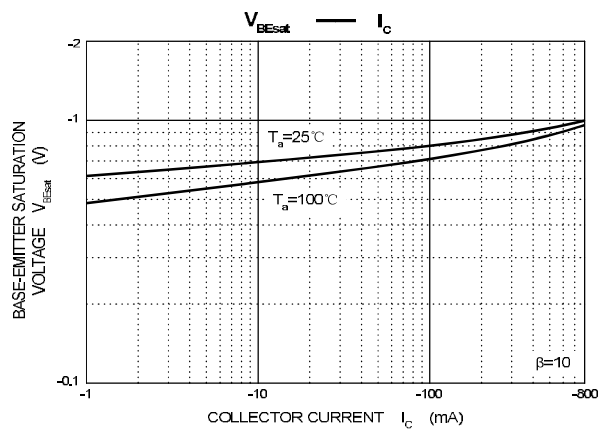
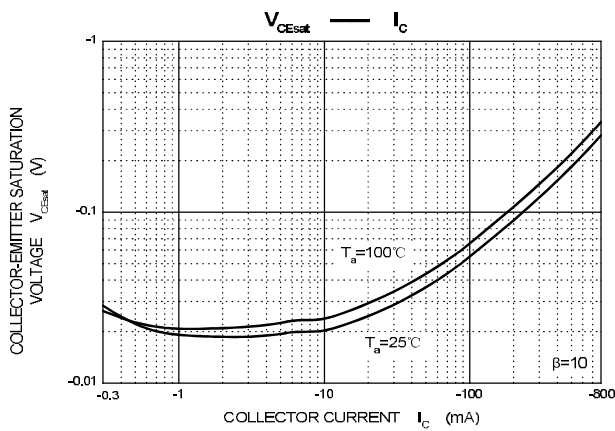
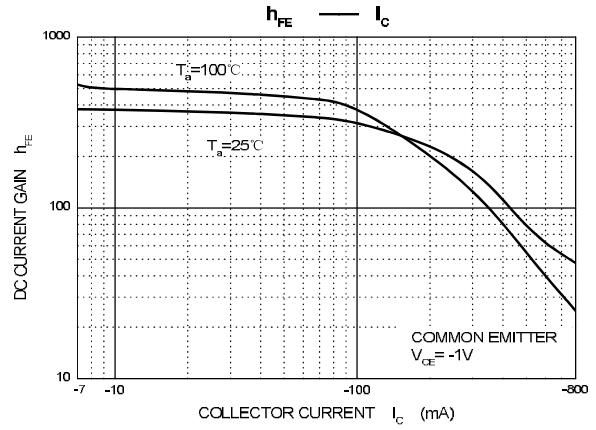
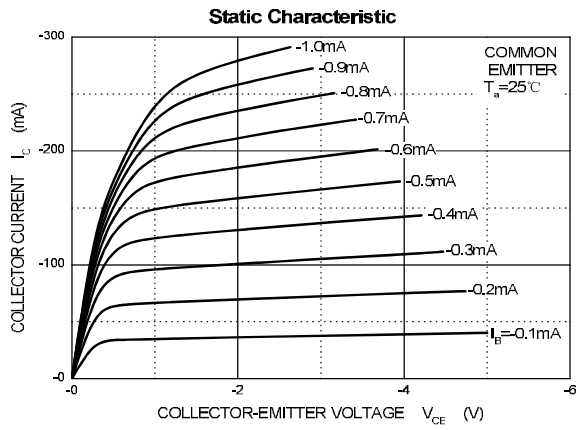

TO-92 Package Outline Dimensions

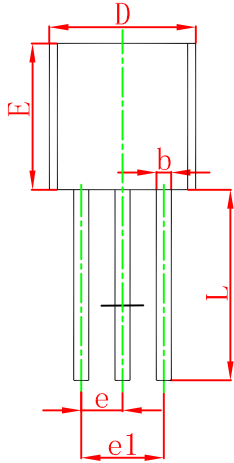
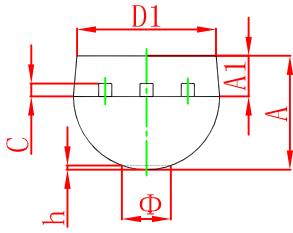

Symbol	Dimensions In Millimeters		Dimensions In Inches	
	Min	Max	Min	Max
A	3.300	3.700	0.130	0.146
A1	1.100	1.400	0.043	0.055
b	0.380	0.550	0.015	0.022
c	0.360	0.510	0.014	0.020
D	4.300	4.700	0.169	0.185
D1	3.430		0.135	
E	4.300	4.700	0.169	0.185
e	1.270 TYP		0.050 TYP	
e1	2.440	2.640	0.096	0.104
L	14.100	14.500	0.555	0.571
Φ		1.600		0.063
h	0.000	0.380	0.000	0.015

TO-92 Suggested Pad Layout

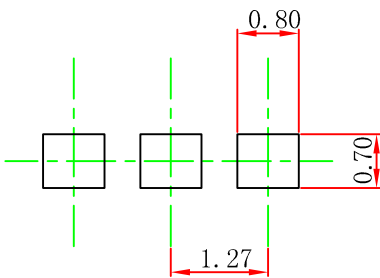

Note:

1. Controlling dimension: in millimeters.
2. General tolerance: ± 0.05 mm.
3. The pad layout is for reference purposes only.

TO-92 PACKAGE TAPEING DIMENSION

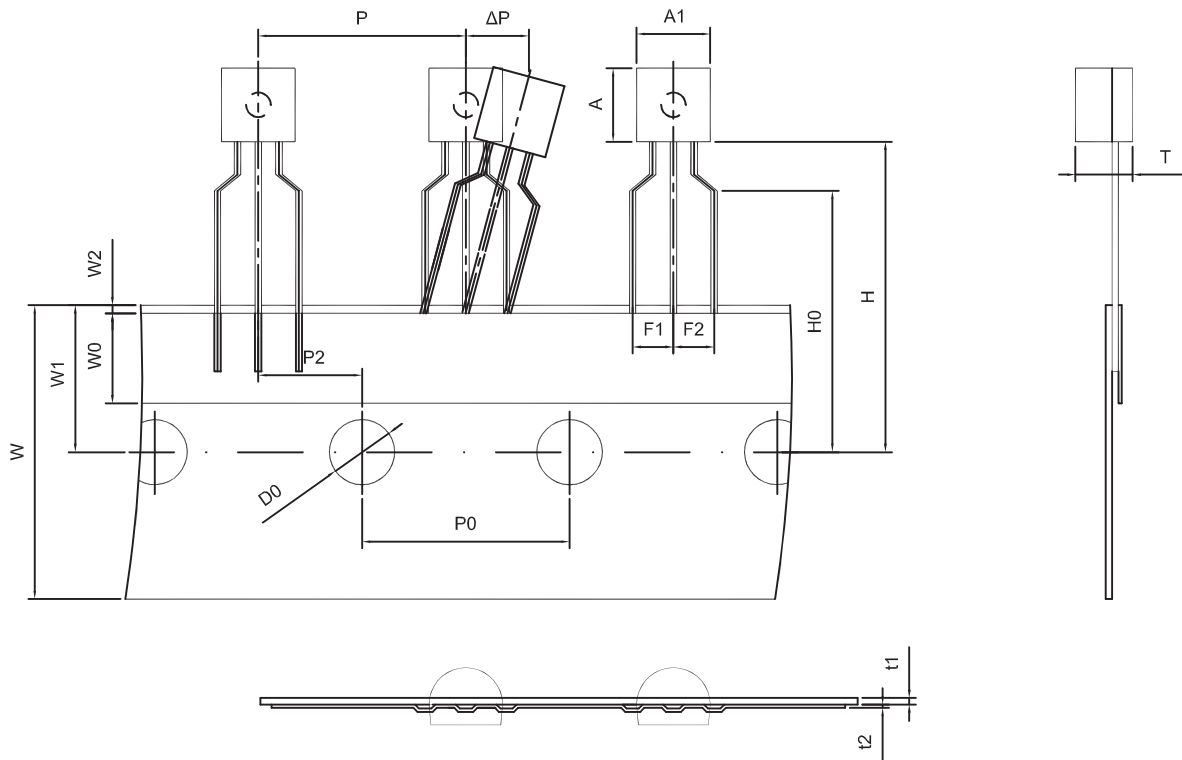

Dimiensions are in millimeter								
A1	A	T	P	P0	P2	F1	F2	W
4.5	4.5	3.5	12.7	12.7	6.35	2.5	2.5	18.0
W0	W1	W2	H	H0	D0	t1	t2	ΔP
6.0	9.0	1.0 MAX.	19.0	16.0	4.0	0.4	0.2	0

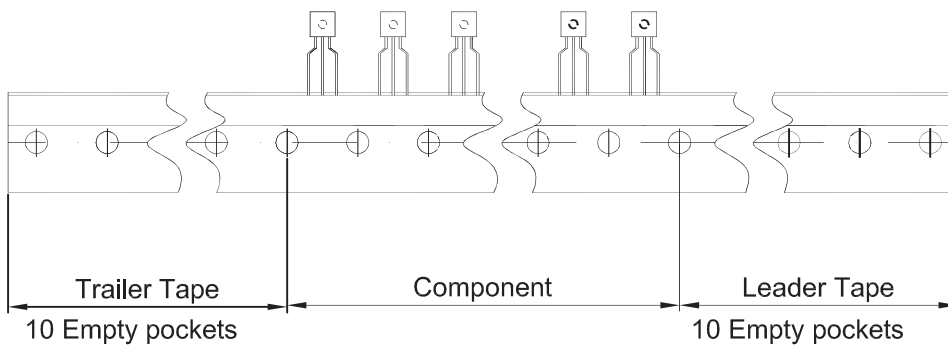

Package	Box	Box Size(mm)	Carton	Carton Size(mm)
TO-92	2000 pcs	333×162×43	20,000 pcs	350×340×250