



DONGGUAN NANJING ELECTRONICS LTD.,

TO-92 Plastic-Encapsulate Transistors

BF421
BF423

TRANSISTOR (PNP)

FEATURES

- Low Feedback Capacitance.
- PNP Transistors in a TO-92 Plastic Package.
NPN Complements: BF420 and BF422
- Class-B Video Output Stages in Colour Television and Professional Monitor Equipment.

TO-92

1. EMITTER
2. COLLECTOR
3. BASE

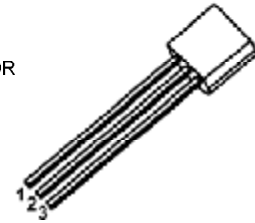

MARKING

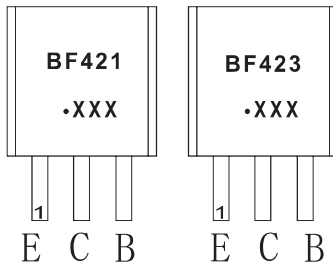

Equivalent Circuit

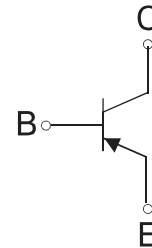

BF421, BF423=Device code

Solid dot=Green molding compound device,
if none, the normal device

XXX=Code

ORDERING INFORMATION

Part Number	Package	Packing Method	Pack Quantity
BF421	TO-92	Bulk	1000pcs/Bag
BF421-TA	TO-92	Tape	2000pcs/Box
BF423	TO-92	Bulk	1000pcs/Bag
BF423-TA	TO-92	Tape	2000pcs/Box

MAXIMUM RATINGS (T_a=25°C unless otherwise noted)

Symbol	Parameter	BF421	BF423	Unit
V _{CBO}	Collector-Base Voltage	-300	-250	V
V _{CEO}	Collector-Emitter Voltage	-300	-250	V
V _{EBO}	Emitter-Base Voltage	-5		V
I _C	Collector Current -Continuous	-100		mA
P _C	Collector Power Dissipation	0.83		W
R _{thja}	Thermal resistance from junction to ambient	151		°C /W
T _j	Junction temperature	150		°C
T _{stg}	Storage Temperature Range	-55~+150		°C

ELECTRICAL CHARACTERISTICS

$T_a=25\text{ }^\circ\text{C}$ unless otherwise specified

Parameter	Symbol	Test conditions	Min	Max	Unit
Collector-base breakdown voltage	BF421 BF423 $V_{(BR)CBO}$	$I_C=-100\mu\text{A}, I_E=0$	-300 -250		V
Collector-emitter breakdown voltage	BF421 BF423 $V_{(BR)CEO}$	$I_C=-1\text{mA}, I_B=0$	-300 -250		V
Emitter-base breakdown voltage	$V_{(BR)EBO}$	$I_E=-100\mu\text{A}, I_C=0$	-5		V
Collector cut-off current	I_{CBO}	$V_{CB}=-200\text{V}, I_E=0$		-0.01	μA
Emitter cut-off current	BF421 BF423 I_{EBO}	$V_{EB}=-5\text{V}, I_C=0$		-0.1 -0.05	μA
DC current gain	h_{FE}	$V_{CE}=-20\text{V}, I_C=-25\text{mA}$	50		
Collector-emitter saturation voltage	BF421 BF423 $V_{CE(sat)}$	$I_C=-20\text{mA}, I_B=-2\text{mA}$ $I_C=-30\text{mA}, I_B=-5\text{mA}$		-0.6	V
Transition frequency	f_T	$V_{CE}=-10\text{V}, I_C=-10\text{mA}$ $f=100\text{MHz}$	60		MHz
Feedback capacitance	C_{re}	$V_{CE}=-30\text{V}, I_C=0, f=1\text{MHz}$		1.6	pF

TO-92 Package Outline Dimensions

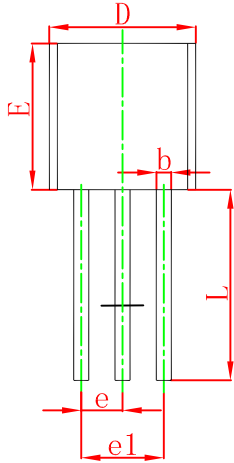
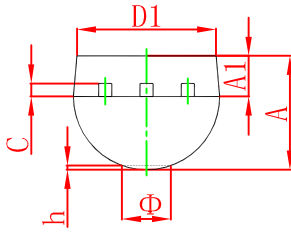

Symbol	Dimensions In Millimeters		Dimensions In Inches	
	Min	Max	Min	Max
A	3.300	3.700	0.130	0.146
A1	1.100	1.400	0.043	0.055
b	0.380	0.550	0.015	0.022
c	0.360	0.510	0.014	0.020
D	4.300	4.700	0.169	0.185
D1	3.430		0.135	
E	4.300	4.700	0.169	0.185
e	1.270 TYP		0.050 TYP	
e1	2.440	2.640	0.096	0.104
L	14.100	14.500	0.555	0.571
Φ		1.600		0.063
h	0.000	0.380	0.000	0.015

TO-92 Suggested Pad Layout

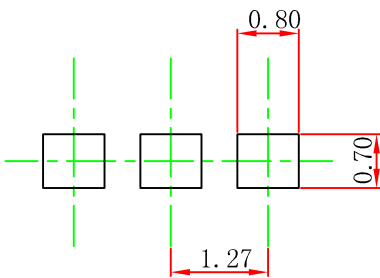

Note:

1. Controlling dimension: in millimeters.
2. General tolerance: $\pm 0.05\text{mm}$.
3. The pad layout is for reference purposes only.

TO-92 PACKAGE TAPEING DIMENSION

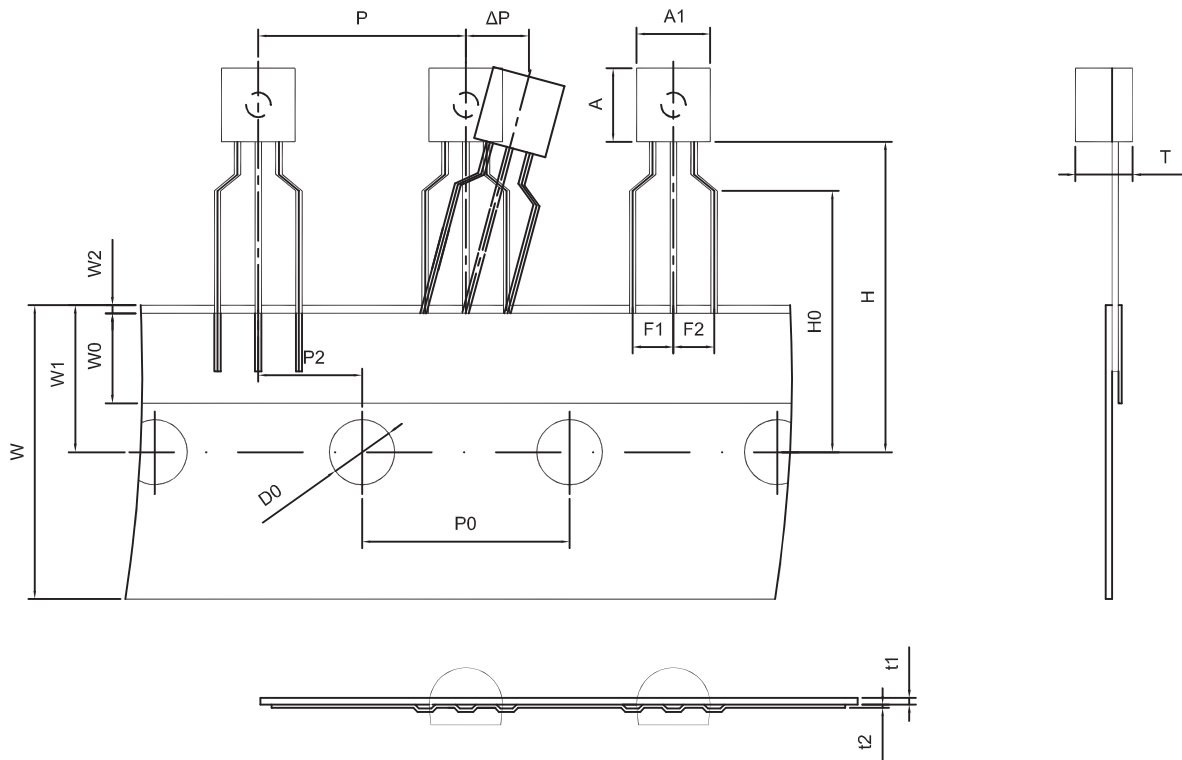

Dimiensions are in millimeter								
A1	A	T	P	P0	P2	F1	F2	W
4.5	4.5	3.5	12.7	12.7	6.35	2.5	2.5	18.0
W0	W1	W2	H	H0	D0	t1	t2	ΔP
6.0	9.0	1.0 MAX.	19.0	16.0	4.0	0.4	0.2	0

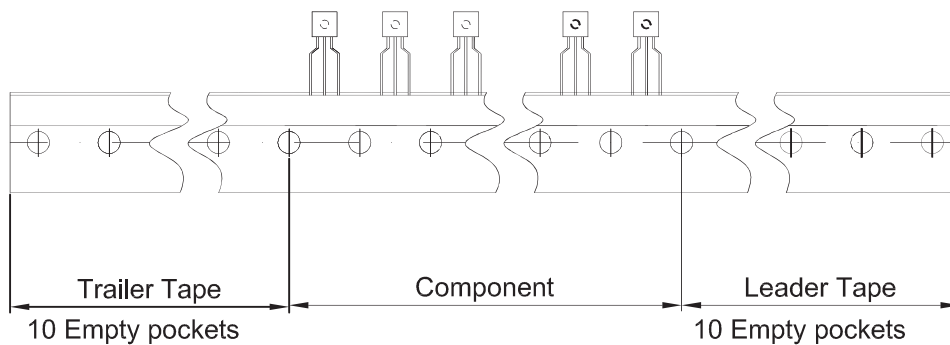

Package	Box	Box Size(mm)	Carton	Carton Size(mm)
TO-92	2000 pcs	333×162×43	20,000 pcs	350×340×250