



# DONGGUAN NANJING ELECTRONICS LTD.,

## TO-92 Plastic-Encapsulate Transistors

### MPSA14 TRANSISTOR (NPN)

#### FEATURES

- Darlington Transistor

TO - 92

1.EMITTER

2.BASE

3.COLLECTOR

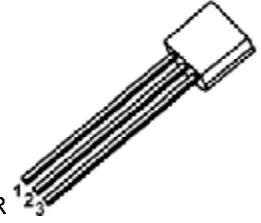

#### MAXIMUM RATINGS ( $T_a=25^{\circ}\text{C}$ unless otherwise noted)

Symbol	Parameter	Value	Unit
$V_{CB0}$	Collector-Base Voltage	30	V
$V_{CE0}$	Collector-Emitter Voltage	30	V
$V_{EB0}$	Emitter-Base Voltage	10	V
$I_C$	Collector Current-Continuous	0.5	A
$P_C$	Collector Power Dissipation	625	mW
$R_{\theta JA}$	Thermal Resistance From Junction To Ambient	200	$^{\circ}\text{C/W}$
$T_j$	Junction Temperature	150	$^{\circ}\text{C}$
$T_{stg}$	Storage Temperature	-55~+150	$^{\circ}\text{C}$

#### ELECTRICAL CHARACTERISTICS ( $T_a=25^{\circ}\text{C}$ unless otherwise specified)

Parameter	Symbol	Test conditions	Min	Typ	Max	Unit
Collector-base breakdown voltage	$V_{(BR)CBO}$	$I_C=0.1\text{mA}, I_E=0$	30			V
Collector-emitter breakdown voltage	$V_{(BR)CEO}$	$I_C=1\text{mA}, I_B=0$	30			V
Emitter-base breakdown voltage	$V_{(BR)EBO}$	$I_E=0.1\text{mA}, I_C=0$	10			V
Collector cut-off current	$I_{CBO}$	$V_{CB}=30\text{V}, I_E=0$			0.1	$\mu\text{A}$
Emitter cut-off current	$I_{EBO}$	$V_{EB}=10\text{V}, I_C=0$			0.1	$\mu\text{A}$
DC current gain	$h_{FE(1)}^*$	$V_{CE}=5\text{V}, I_C=10\text{mA}$	10000			
	$h_{FE(2)}^*$	$V_{CE}=5\text{V}, I_C=100\text{mA}$	20000			
Collector-emitter saturation voltage	$V_{CE(sat)}^*$	$I_C=100\text{mA}, I_B=0.1\text{mA}$			1.5	V
Base-emitter voltage	$V_{BE}^*$	$V_{CE}=5\text{V}, I_C=100\text{mA}$			2.0	V
Transition frequency	$f_T$	$V_{CE}=5\text{V}, I_C=10\text{mA}, f=100\text{MHz}$	125			MHz

\*Pulse test: pulse width  $\leq 300\mu\text{s}$ , duty cycle  $\leq 2.0\%$ .

# Typical Characteristics

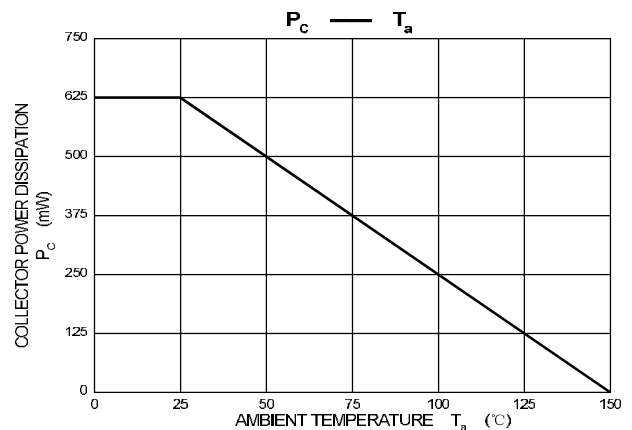
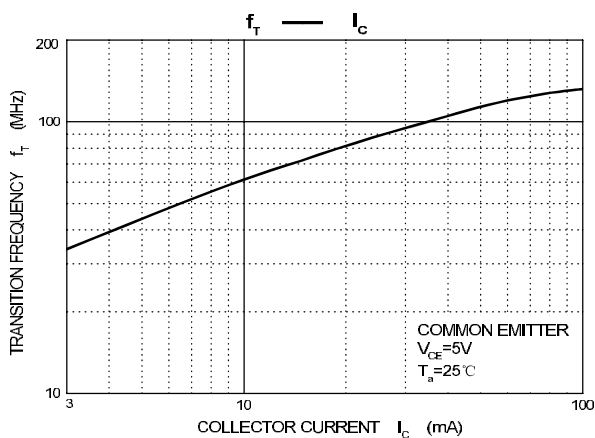
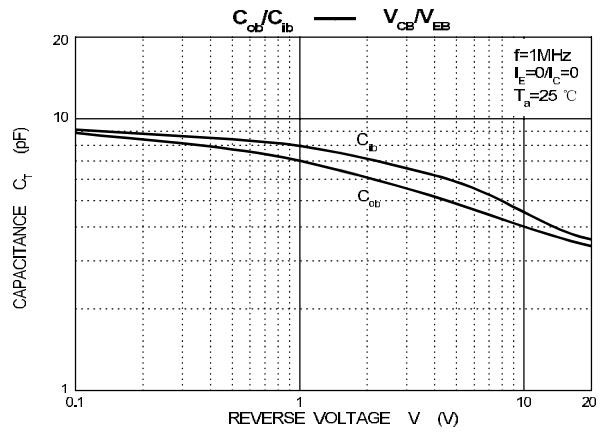
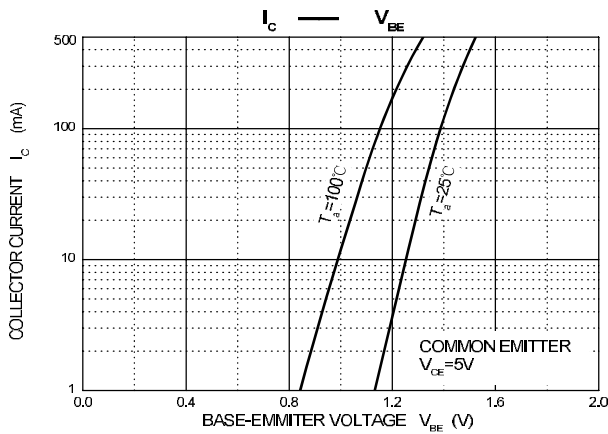
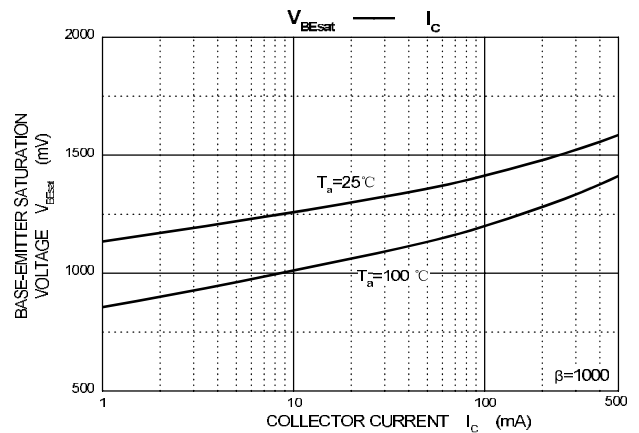
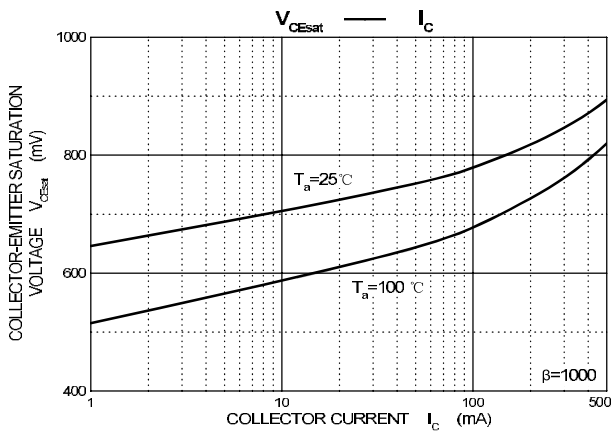
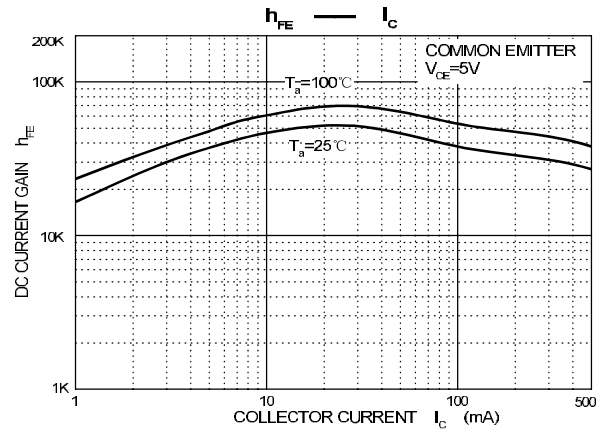
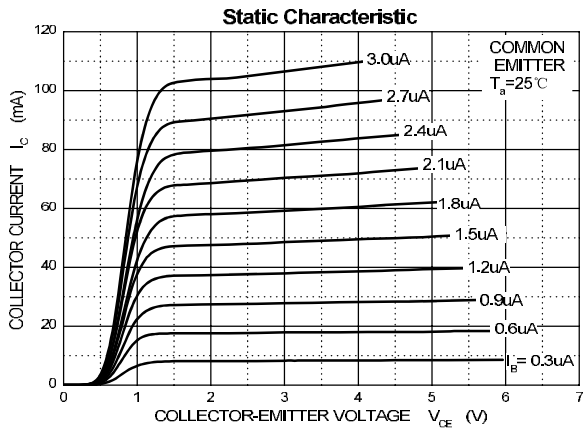

## TO-92 Package Outline Dimensions

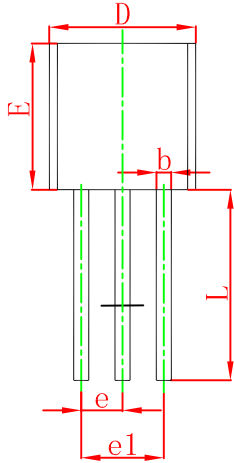
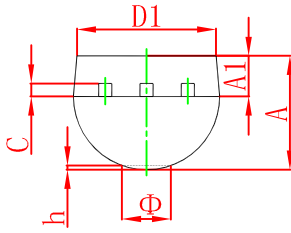

Symbol	Dimensions In Millimeters		Dimensions In Inches	
	Min	Max	Min	Max
A	3.300	3.700	0.130	0.146
A1	1.100	1.400	0.043	0.055
b	0.380	0.550	0.015	0.022
c	0.360	0.510	0.014	0.020
D	4.300	4.700	0.169	0.185
D1	3.430		0.135	
E	4.300	4.700	0.169	0.185
e	1.270 TYP		0.050 TYP	
e1	2.440	2.640	0.096	0.104
L	14.100	14.500	0.555	0.571
Φ		1.600		0.063
h	0.000	0.380	0.000	0.015

## TO-92 Suggested Pad Layout

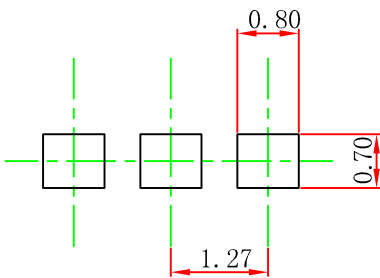

### Note:

1. Controlling dimension: in millimeters.
2. General tolerance:  $\pm 0.05$ mm.
3. The pad layout is for reference purposes only.

TO-92 PACKAGE TAPEING DIMENSION

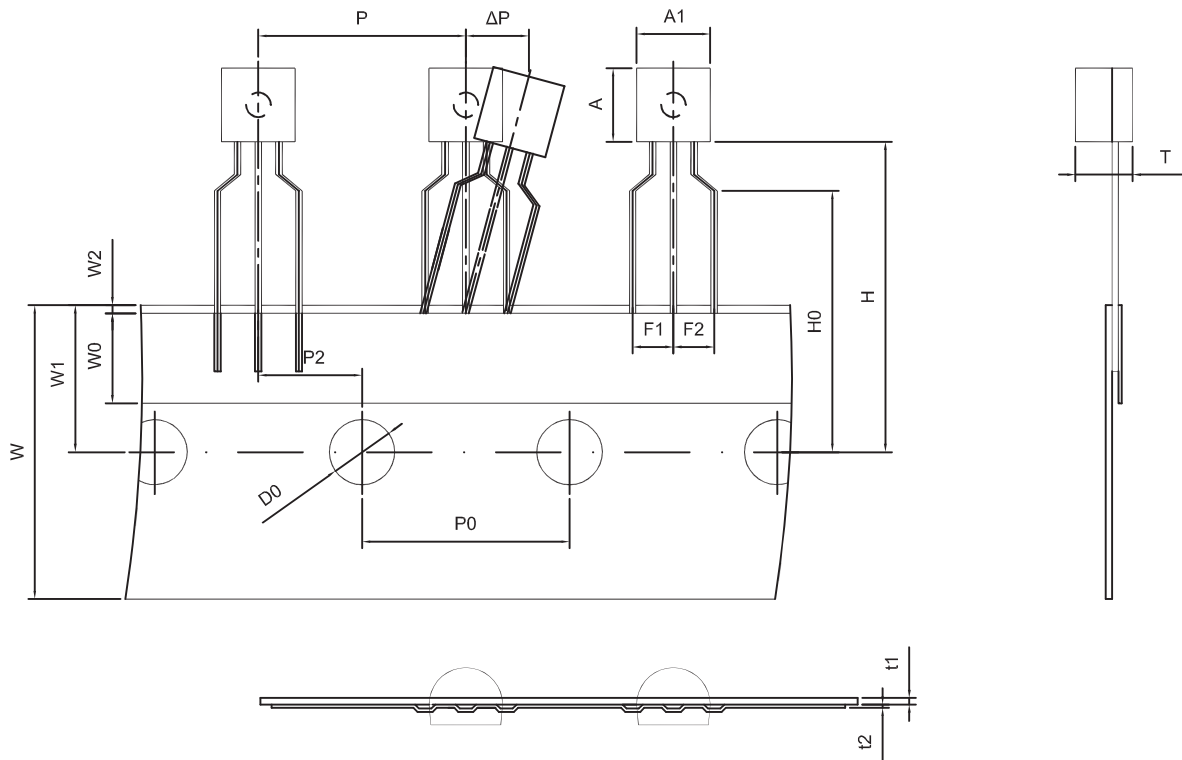

Dimiensions are in millimeter

A1	A	T	P	P0	P2	F1	F2	W
4.5	4.5	3.5	12.7	12.7	6.35	2.5	2.5	18.0
W0	W1	W2	H	H0	D0	t1	t2	ΔP
6.0	9.0	1.0 MAX.	19.0	16.0	4.0	0.4	0.2	0

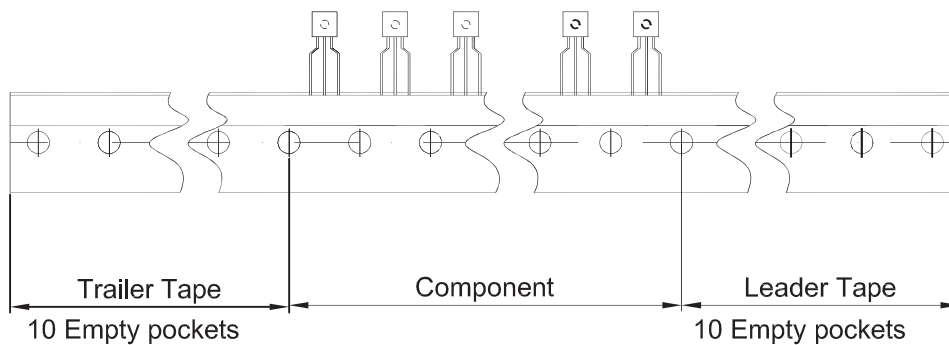

Package	Box	Box Size(mm)	Carton	Carton Size(mm)
TO-92	2000 pcs	333×162×43	20,000 pcs	350×340×250