



DONGGUAN NANJING ELECTRONICS LTD.,

## TO-220-3L Plastic-Encapsulate Transistors

### TIP41/41A/41B/41C TRANSISTOR (NPN)

#### FEATURES

Medium Power Linear Switching Applications

#### TO-220-3L

1. BASE
2. COLLECTOR
3. EMITTER

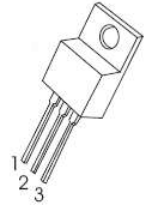

#### MAXIMUM RATINGS (T<sub>a</sub>=25°C unless otherwise noted)

Symbol	Parameter	TIP41	TIP41A	TIP41B	TIP41C	Unit
V <sub>CB0</sub>	Collector-Base Voltage	40	60	80	100	V
V <sub>CEO</sub>	Collector-Emitter Voltage	40	60	80	100	V
V <sub>EBO</sub>	Emitter-Base Voltage	5				V
I <sub>C</sub>	Collector Current -Continuous	6				A
P <sub>C</sub>	Collector Power Dissipation	2				W
T <sub>J</sub>	Junction Temperature	150				°C
T <sub>stg</sub>	Storage Temperature Range	-55~+150				°C

#### ELECTRICAL CHARACTERISTICS (T<sub>a</sub>=25°C unless otherwise specified)

Parameter	Symbol	Test conditions	Min	Max	Unit	
Collector-base breakdown voltage	TIP41	I <sub>C</sub> = 1mA, I <sub>E</sub> =0	40		V	
	TIP41A		60			
	TIP41B		80			
	TIP41C		100			
Collector-emitter breakdown voltage	TIP41	I <sub>C</sub> = 30mA, I <sub>B</sub> =0	40		V	
	TIP41A		60			
	TIP41B		80			
	TIP41C		100			
Emitter-base breakdown voltage	V <sub>(BR)EBO</sub>	I <sub>E</sub> = 1mA, I <sub>C</sub> =0	5		V	
Collector cut-off current	TIP41	V <sub>CB</sub> =40V, I <sub>E</sub> =0 V <sub>CB</sub> =60V, I <sub>E</sub> =0 V <sub>CB</sub> =80V, I <sub>E</sub> =0 V <sub>CB</sub> =100V, I <sub>E</sub> =0	0.4		mA	
	TIP41A					
	TIP41B					
	TIP41C					
Collector cut-off current	TIP41/41A TIP41B/41C	I <sub>CEO</sub>	V <sub>CE</sub> = 30V, I <sub>B</sub> = 0 V <sub>CE</sub> = 60V, I <sub>B</sub> = 0	0.7		mA
Emitter cut-off current		I <sub>EBO</sub>	V <sub>EB</sub> =5V, I <sub>C</sub> =0		1	mA
DC current gain		h <sub>FE(1)</sub>	V <sub>CE</sub> = 4V, I <sub>C</sub> = 0.3A	30		
		h <sub>FE(2)</sub>	V <sub>CE</sub> =4 V, I <sub>C</sub> = 3A	15	75	
Collector-emitter saturation voltage		V <sub>CE(sat)</sub>	I <sub>C</sub> =6A, I <sub>B</sub> =0.6A		1.5	V
Base-emitter voltage		V <sub>BE(on)</sub>	V <sub>CE</sub> = 4V, I <sub>C</sub> =6A		2	V
Transition frequency		f <sub>T</sub>	V <sub>CE</sub> =10V, I <sub>C</sub> =0.5A f =1MHz	3		MHz

# Typical Characteristics

# TIP41/41A/41B/41C

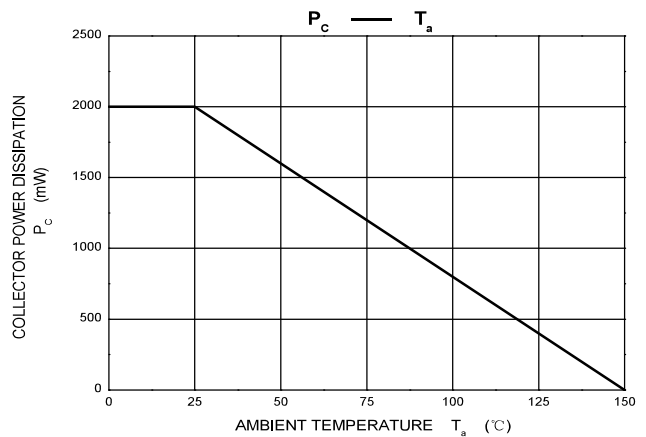
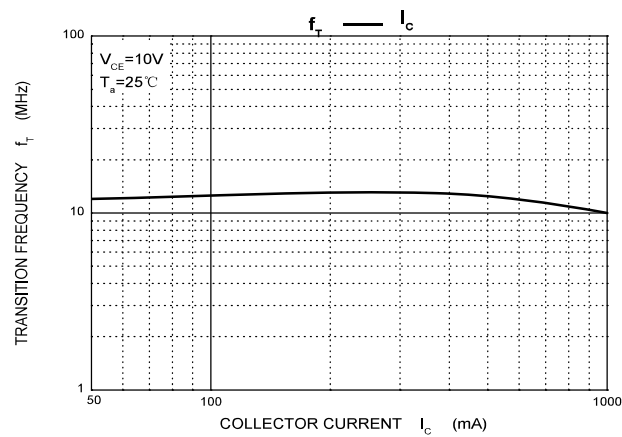
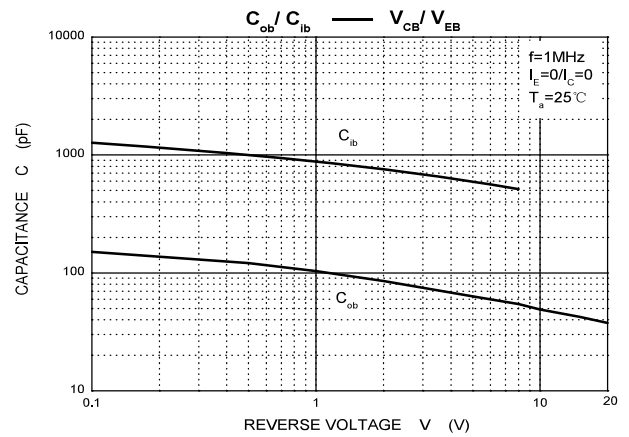
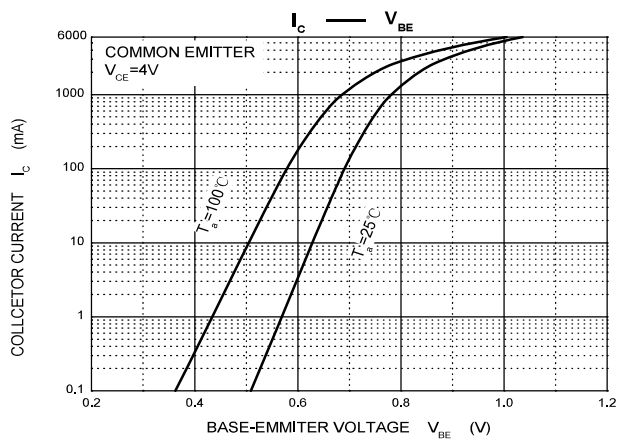
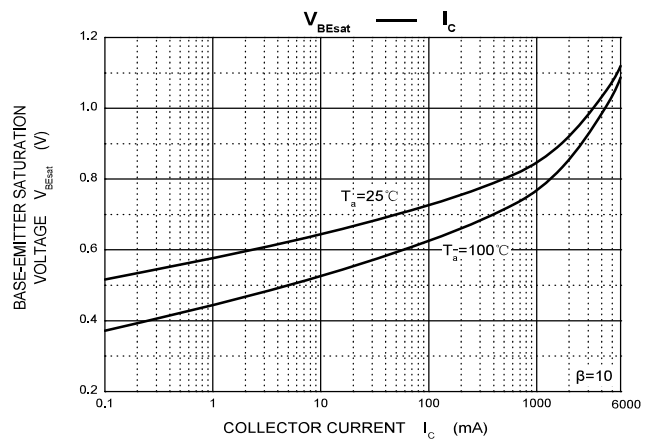
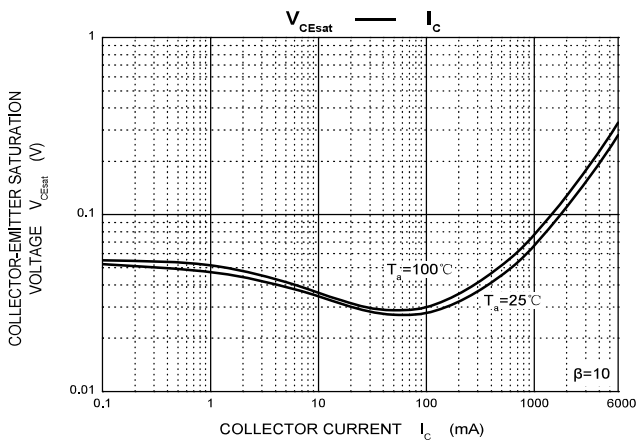
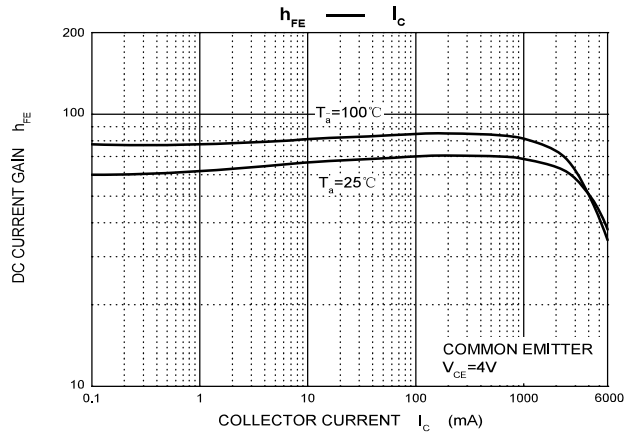
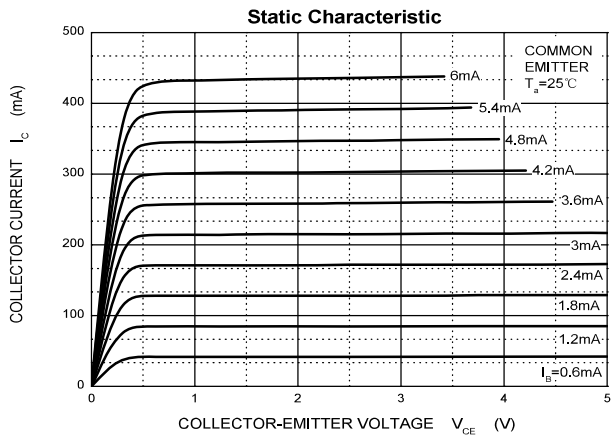

# TO-220-3L Package Outline Dimensions

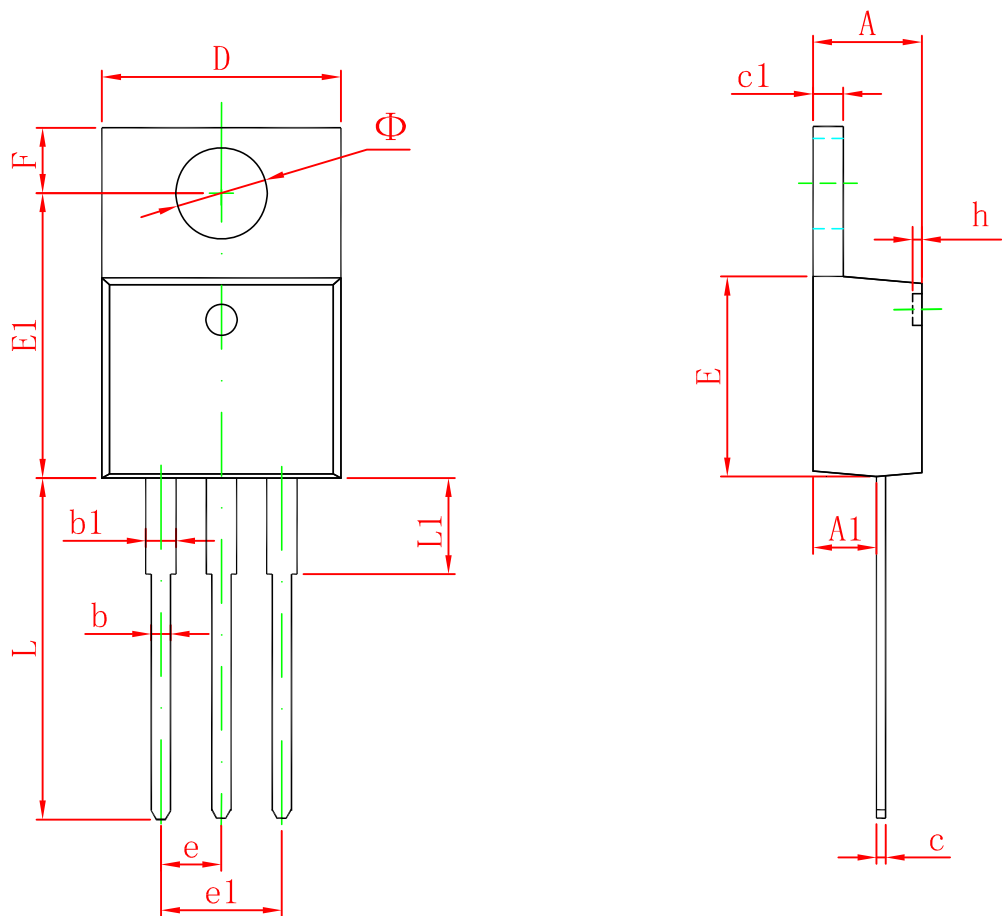

Symbol	Dimensions In Millimeters		Dimensions In Inches	
	Min	Max	Min	Max
A	4.470	4.670	0.176	0.184
A1	2.520	2.820	0.099	0.111
b	0.710	0.910	0.028	0.036
b1	1.170	1.370	0.046	0.054
c	0.310	0.530	0.012	0.021
c1	1.170	1.370	0.046	0.054
D	10.010	10.310	0.394	0.406
E	8.500	8.900	0.335	0.350
E1	12.060	12.460	0.475	0.491
e	2.540 TYP		0.100 TYP	
e1	4.980	5.180	0.196	0.204
F	2.590	2.890	0.102	0.114
h	0.000	0.300	0.000	0.012
L	13.400	13.800	0.528	0.543
L1	3.560	3.960	0.140	0.156
$\Phi$	3.735	3.935	0.147	0.155