



给移动设备提供电力及  
信号的高信赖输送系统

# 照明母线滑触线

Lighting bus sliding contact line

**昊睿森（武汉）智能输送系统有限公司**

Hao Rui Sen (Wuhan) Intelligent Transportation System Co., Ltd



## 公司介绍

昊睿森（武汉）智能输送系统有限公司前身为“武汉勤工机电设备有限公司”。公司专注于移动供电、轻载输送、起重及输送配套、机电、工业自动化、低压成套开关设备及控制设备的多元化产品设计研发销售与维护。专业为客户提供定制化一整套专业的移动供电、轻载输送及低压控制方案。

昊睿森引进欧美科技，依托台湾总部先进的管理及生产理念，拥有完善、科学的质量管制体系。其诚信、实力和产品获得业界的广泛认可。欢迎各界朋友莅临参观，指导和业务洽谈。

## About Hao Rui Sen

Hao Rui Sen (Wuhan) Intelligent Transportation System Co., Ltd. is formerly known as "Wuhan Hard work Mechanical & Electrical Equipment Co., Ltd.". Our Company focuses on mobile powersupply, light load transportation, lifting and transportation matching, mechanical, electrical and industrial automation. We also pays attention to the sales and maintenance of the low-voltages witchgear and diversified design of control equipment. The company will set up a series of particular professional lifting, transportation solutions to their industry's customers.

Hao RuiSen introduces into the advanced technology from European and American countries, relies on Taiwan's headquarters' advanced management and production philosophy. Thus it has a sound and scientific quality-management system. Its integrity, strength and high-quality products have been widely recognized. Welcome friends from all walks of life come here to visit, to give us some precious guidance and also we can have the peaceful business negotiations.



# 照明母线滑触线



本系列滑触线专用于服装及鞋帽的供电照明系统。结合国内服装鞋帽和电子行业的现状，经过潜心研制，不断创新，开发出安全、阻燃、美观、节能、灵活及使用寿命长久的新一代供电照明母线槽。产品新、档次高、品种多，广泛应用于新厂、老厂改扩建过程中的电缆布线工程，以及地下停车场、商场、展览大厅、超市、装配生产线等场所的大面积照明和小型用电设备的供配电。本产品可取代常见电缆架，及市场上现有中高档母线滑触线。

<p><b>专业</b> 完备的知识技能，以环境需求专业定制移动供电、轻载输送低压控制整套方案；</p> <p><b>品质</b> 以先进的生产设备为硬件，引进欧美科技以及先进工艺为软件，打造高端质量；</p> <p><b>安全</b> 考究科学的选材与符合国际安全要求的设计，让用户放心更舒心；</p> <p><b>高效</b> 以质量为基础、安全为保障，专业定制方案，节省而高效，满足你的要求；</p> <p><b>服务</b> 明智的选择是顾客的权益，产品的信誉是我们的责任，昊睿森竭诚为你服务；</p>	<p>公司介绍 1</p> <p>目录 2</p> <p>照明母线滑触线 3</p> <p>照明母线滑触线 HGS7 型 3</p> <p>照明母线滑触线 HGSL7 型 4</p> <p>连接夹 5</p> <p>吊夹 5</p> <p>端供端冒 6</p> <p>照明母线滑触线部分配件 6</p> <p>我们的案例 7</p> <p>我们服务的客户 7</p>
---	---

照明母线滑触线 HGS7 型

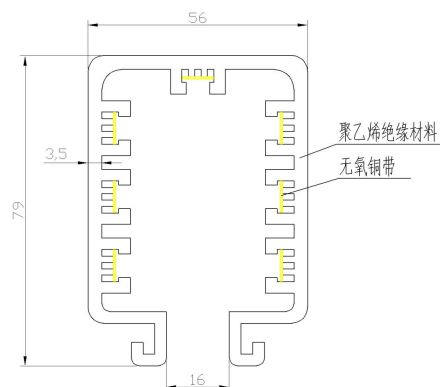
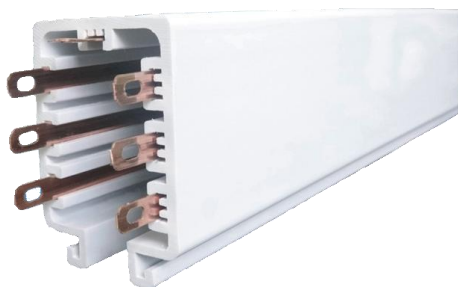

HGS7-7/30

特点：可以根据实际需要选用单相或三相插座，且可安装在任何需要的位置而不需要事先预制。

照明母线滑触线选型

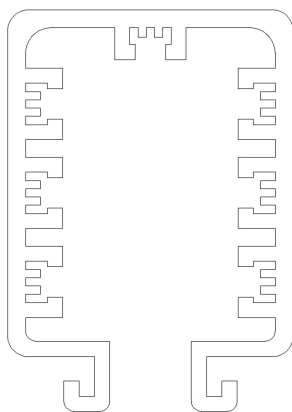

HGS7

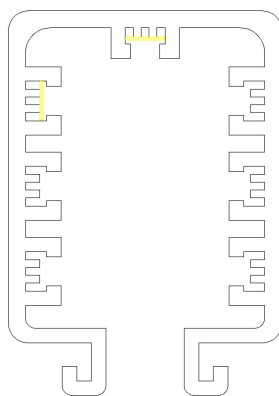

HGS7-2/30

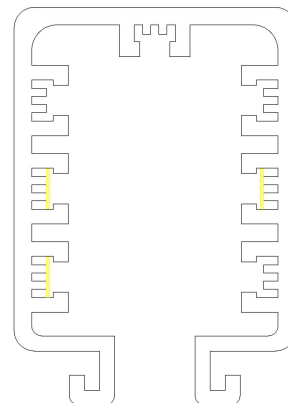

HGS7-3/30

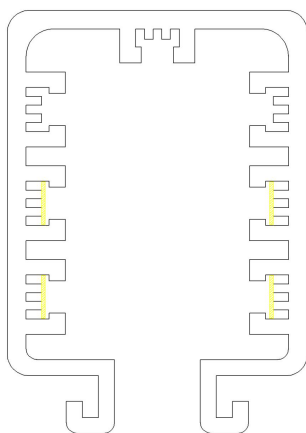

HGS7-4/30

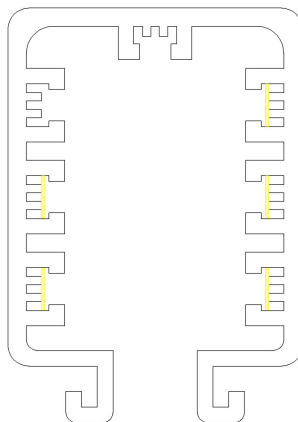

HGS7-5/30

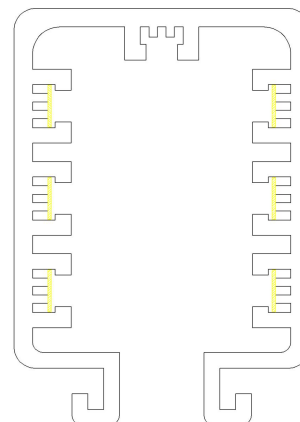

HGS7-6/30



型号	相数 x 单相 截面积	规格	重量	材质	物料编码
HGS7	—	30A	kg/m	聚乙烯	01091001
HGS7-2/30	2×6mm <sup>2</sup>	30A	kg/m	聚乙烯/无氧铜	01091002
HGS7-3/30	3×6mm <sup>2</sup>	30A	kg/m	聚乙烯/无氧铜	01091003
HGS7-4/30	4×6mm <sup>2</sup>	30A	kg/m	聚乙烯/无氧铜	01091004
HGS7-5/30	5×6mm <sup>2</sup>	30A	kg/m	聚乙烯/无氧铜	01091005
HGS7-6/30	6×6mm <sup>2</sup>	30A	kg/m	聚乙烯/无氧铜	01091006
HGS7-7/30	7×6mm <sup>2</sup>	30A	kg/m	聚乙烯/无氧铜	01091007

照明母线滑触线 HGSL7 型

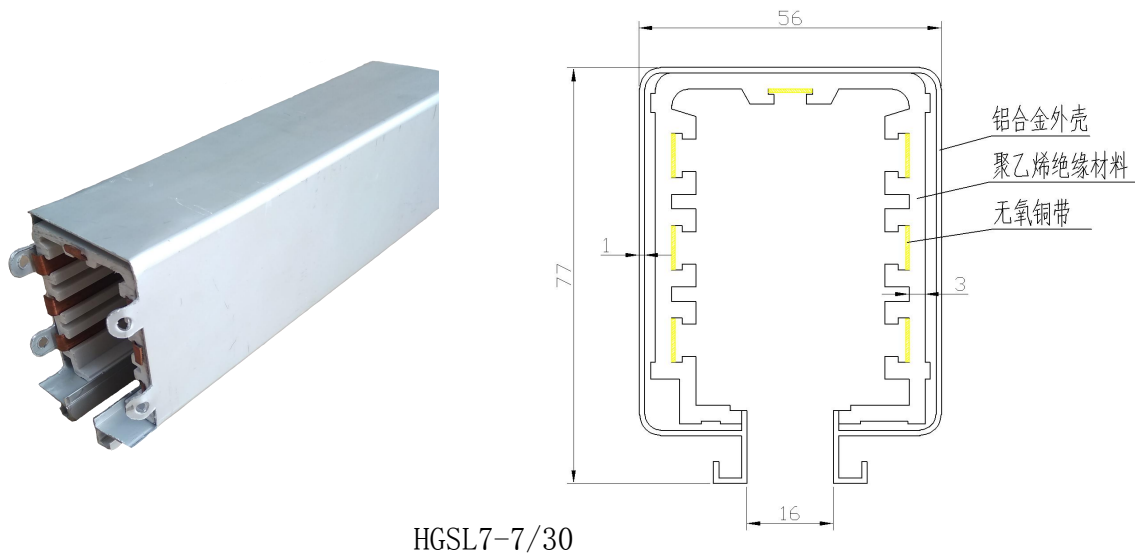

HGSL7-7/30

特点：可以根据实际需要选用单相或三相插座，且可安装在任何需要的位置而不需要事先预制。

照明母线滑触线选型

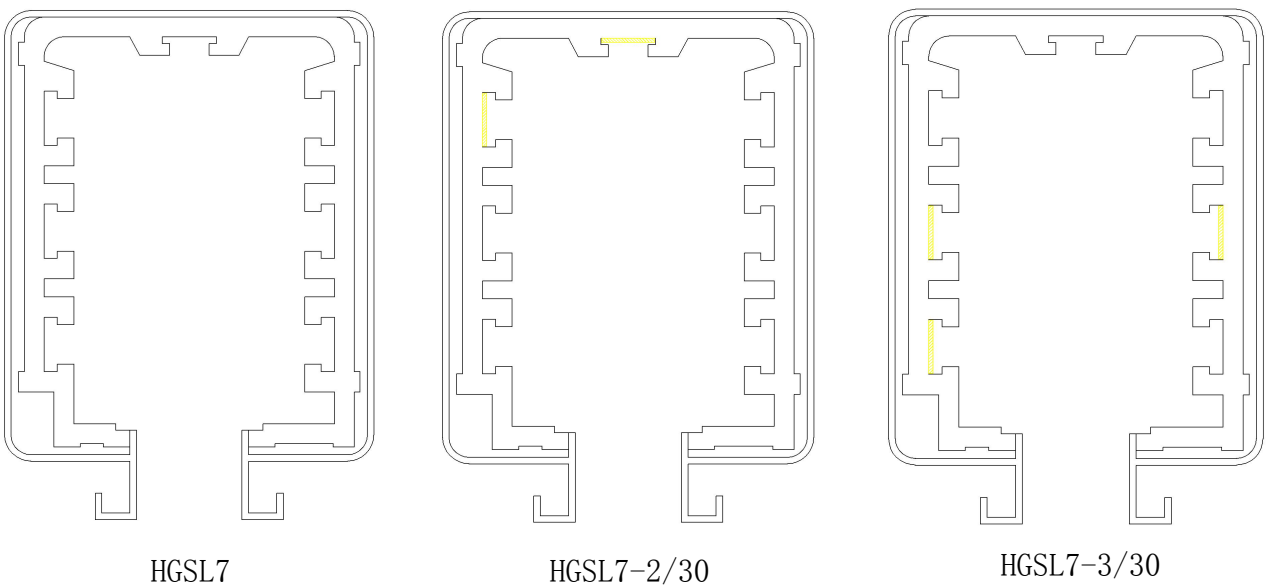

HGSL7

HGSL7-2/30

HGSL7-3/30

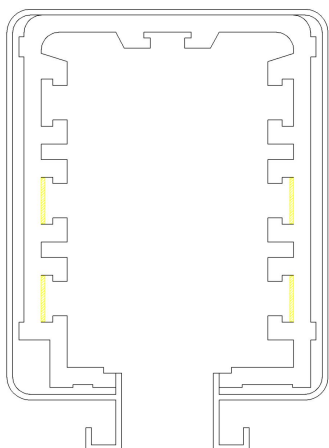

HGSL7-4/30

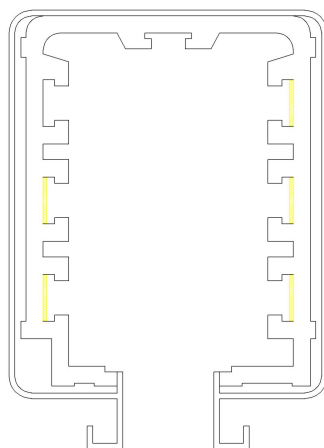

HGSL7-5/30

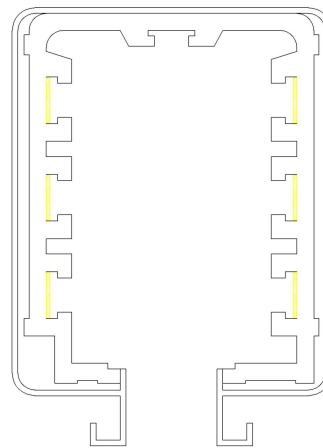

HGSL7-6/30

型号	相数 x 单相 截面积	规格	重量	材质	物料编码
HGSL7	--	30A	kg/m	聚乙烯/铝合金	01091101
HGSL7-2/30	2×6mm <sup>2</sup>	30A	kg/m	聚乙烯/铝合金/无氧铜	01091102
HGSL7-3/30	3×6mm <sup>2</sup>	30A	kg/m	聚乙烯/铝合金/无氧铜	01091103
HGSL7-4/30	4×6mm <sup>2</sup>	30A	kg/m	聚乙烯/铝合金/无氧铜	01091104
HGSL7-5/30	5×6mm <sup>2</sup>	30A	kg/m	聚乙烯/铝合金/无氧铜	01091105
HGSL7-6/30	6×6mm <sup>2</sup>	30A	kg/m	聚乙烯/铝合金/无氧铜	01091106
HGSL7-7/30	7×6mm <sup>2</sup>	30A	kg/m	聚乙烯/铝合金/无氧铜	01091107

### 连接夹

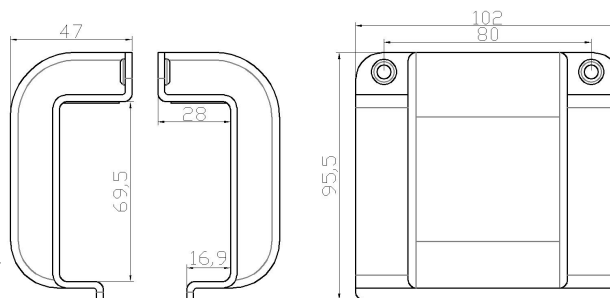

型号	重量	材质	物料编码
HGSL72	0.04kg	工程塑料	01091201

### 吊夹



型号	重量	材质	物料编码
HGSL73	0.22kg	不锈钢	01091211



型号	重量	材质	物料编码
HGSL74	0.09kg	工程塑料	01091221

## 照明母线滑触线部分配件

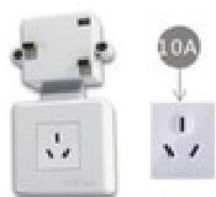

移动单插座（220V/10A）  
型号：HGS-YC(1P10)  
物料编码：01091301



移动单插座（380V/16A）  
型号：HGS-YC(3P16)  
物料编码：01091311



移动单插座（220V/16A）  
型号：HGS-YC(1P16A)  
物料编码：01091321



移动单插座（多功能）  
型号：HGS-YC(1P10)  
物料编码：01091331



移动双插座(220V+380V)  
型号：HGS-YC(1P+3P)  
物料编码：01091341



移动单插座（3P+N+E）  
型号：HGS-YC(3P+N+E)  
物料编码：01091351



定制移动供电插座  
型号：带开关控制型  
物料编码：01091361



大三圆移动插座（带开关）  
型号：大三圆  
物料编码：01091371



定制移动供电插座  
型号：款标  
物料编码：01091381



定制移动供电插座  
型号：带漏电保护型  
物料编码：01091391



七极裁剪移动插座 380V  
型号：HGS-7CJ(3P16)  
物料编码：01091401



七极裁剪移动插座 220V  
型号：HGS-7CJ(1P10)  
物料编码：01091411



七极裁剪移动插座(工业插座)  
型号：HGS-7CJ(1P16)  
物料编码：01091421



旋转接驳器 (三相五线)  
型号：HGS-XJ(3P+N+E)  
物料编码：01091431



旋转接驳器 (220V)  
型号：HGS-XJ(1P10)  
物料编码：01091441



旋转接驳器 (380V)  
型号：HGS-XJ(3P16)  
物料编码：01091451



旋转插座 (220V)  
型号：HGS-XC(1P10)  
物料编码：01091461

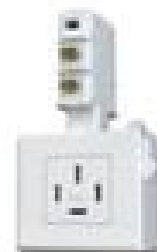

旋转插座 (380V)  
型号：HGS-XC(3P16)  
物料编码：01091471



86 型美标旋转插座 220V  
型号：HGS-86XC(3/10A)  
物料编码：01091481



86 型英标旋转插座 220V  
型号：HGS-86XC(3/13A)  
物料编码：01091491



86 型欧标旋转插座 220V  
型号：HGS-86XC(3/16A)  
物料编码：01091501



86 型三大圆旋转插座 220V  
型号：HGS-86XC(3/15A)  
物料编码：01091511



## 照明母线滑触线系列 我们的案例

HHRS 昊睿森（武汉）智能输送系统有限公司

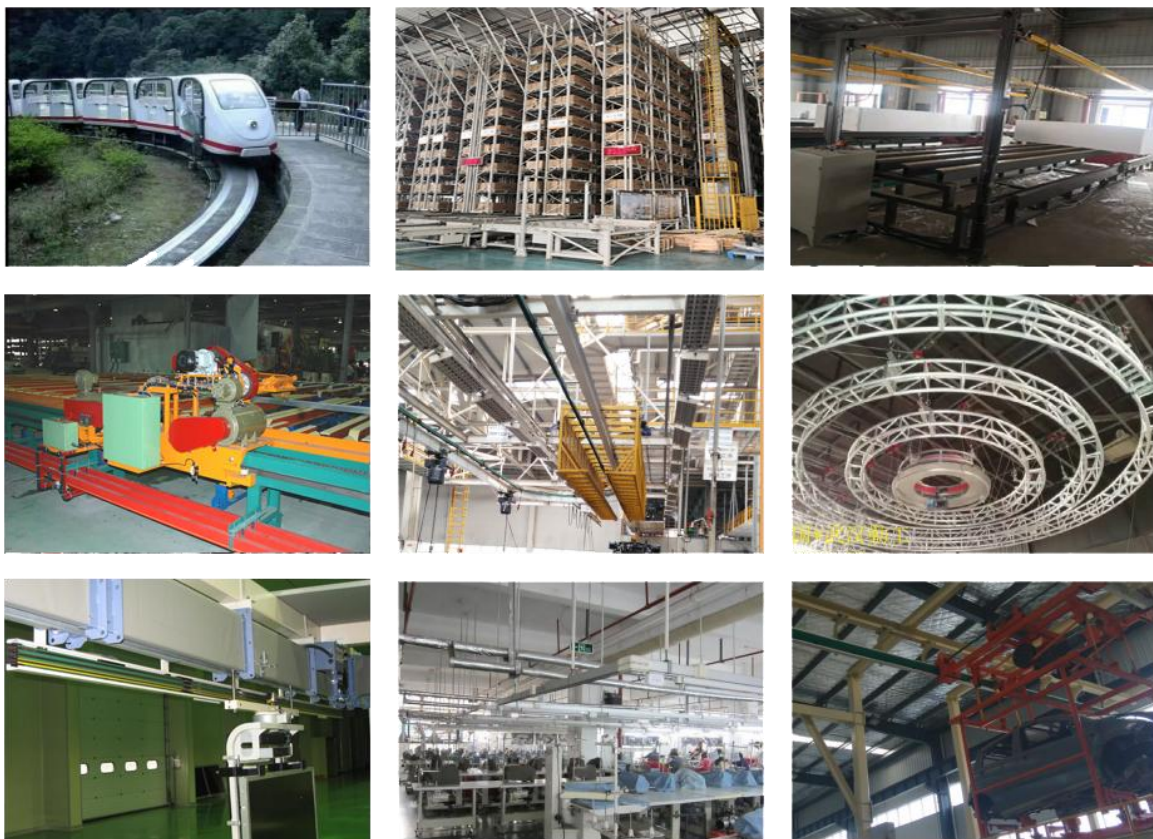

## 我们服务的客户



专业、质量、安全、高效



请联系我们授权的代理商：

---

### 昊睿森（武汉）智能输送系统有限公司

Hao Rui Sen (Wuhan) Intelligent Transportation System Co., Ltd

地址：武汉市江夏区纸金东路 275 号天元创投产业园 1 栋

邮编：430000

电话：+86 027-88089919

传真：+86 027-88089919

邮箱：hhrs88089919@163.com

网址：www.c-hhrs.com

