



DONGGUAN NANJING ELECTRONICS LTD.,  
**TO-126 Plastic-Encapsulate Transistors**

**MJE172** TRANSISTOR (PNP)

**FEATURES**

- Low Power Audio Amplifier
- Low Current, High Speed Switching Applications

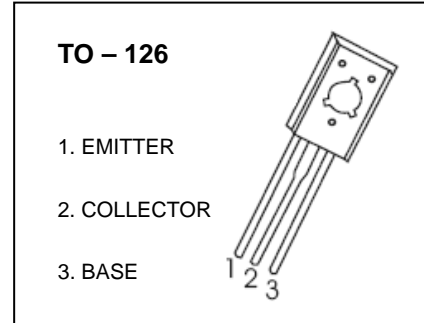

**MARKING**

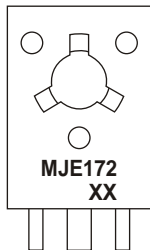

MJE172=Device code  
XX=Code

**Equivalent Circuit**

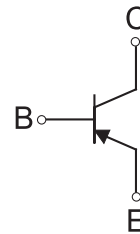

**ORDERING INFORMATION**

Part Number	Package	Packing Method	Pack Quantity
MJE172	TO-126	Bulk	200pcs/Bag
MJE172-TU	TO-126	Tube	60pcs/Tube

**MAXIMUM RATINGS (T<sub>a</sub>=25°C unless otherwise noted)**

Symbol	Parameter	Value	Unit
V <sub>CBO</sub>	Collector-Base Voltage	-100	V
V <sub>CEO</sub>	Collector-Emitter Voltage	-80	V
V <sub>EBO</sub>	Emitter-Base Voltage	-7	V
I <sub>C</sub>	Collector Current	-3	A
P <sub>C</sub>	Collector Power Dissipation	1.5	W
R <sub>θJA</sub>	Thermal Resistance From Junction To Ambient	83	°C/W
T <sub>J</sub> , T <sub>stg</sub>	Operation Junction and Storage Temperature Range	-55~+150	°C

## ELECTRICAL CHARACTERISTICS

$T_a=25\text{ }^\circ\text{C}$  unless otherwise specified

Parameter	Symbol	Test conditions	Min	Typ	Max	Unit
Collector-base breakdown voltage	$V_{(BR)CBO}$	$I_C=-1\text{mA}, I_E=0$	-100			V
Collector-emitter breakdown voltage	$V_{(BR)CEO}$	$I_C=-10\text{mA}, I_B=0$	-80			V
Emitter-base breakdown voltage	$V_{(BR)EBO}$	$I_E=-1\text{mA}, I_C=0$	-7			V
Collector cut-off current	$I_{CBO}$	$V_{CB}=-100\text{V}, I_E=0$			-0.1	$\mu\text{A}$
Emitter cut-off current	$I_{EBO}$	$V_{EB}=-7\text{V}, I_C=0$			-0.1	$\mu\text{A}$
DC current gain	$h_{FE(1)}$	$V_{CE}=-1\text{V}, I_C=-100\text{mA}$	50		250	
	$h_{FE(2)}$	$V_{CE}=-1\text{V}, I_C=-500\text{mA}$	30			
	$h_{FE(3)}$	$V_{CE}=-1\text{V}, I_C=-1.5\text{A}$	12			
Collector-emitter saturation voltage	$V_{CE(sat)}$	$I_C=-500\text{mA}, I_B=-50\text{mA}$			-0.3	V
		$I_C=-3\text{A}, I_B=-600\text{mA}$			-1.7	V
Base-emitter saturation voltage	$V_{BE(sat)}$	$I_C=-1.5\text{A}, I_B=-150\text{mA}$			-1.5	V
		$I_C=-3\text{A}, I_B=-600\text{mA}$			-2	V
Base-emitter voltage	$V_{BE}$	$V_{CE}=-1\text{V}, I_C=-500\text{mA}$			-1.2	V
Collector output capacitance	$C_{ob}$	$V_{CB}=-10\text{V}, I_E=0, f=10\text{MHz}$			50	pF
Transition frequency	$f_T$	$V_{CE}=-10\text{V}, I_C=-100\text{mA}, f=10\text{MHz}$	50			MHz

# Typical Characteristics

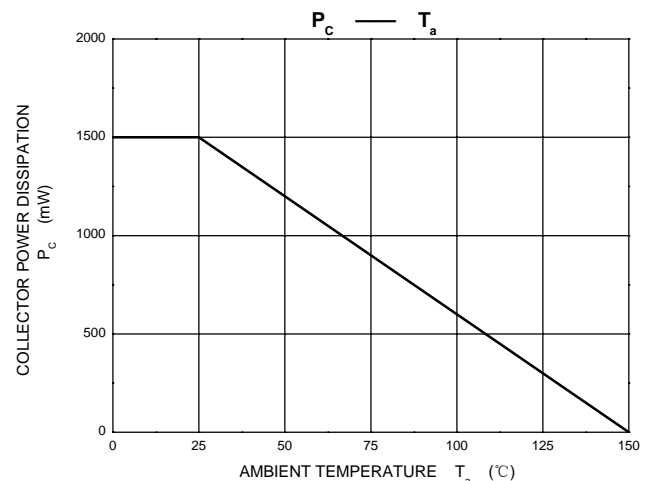
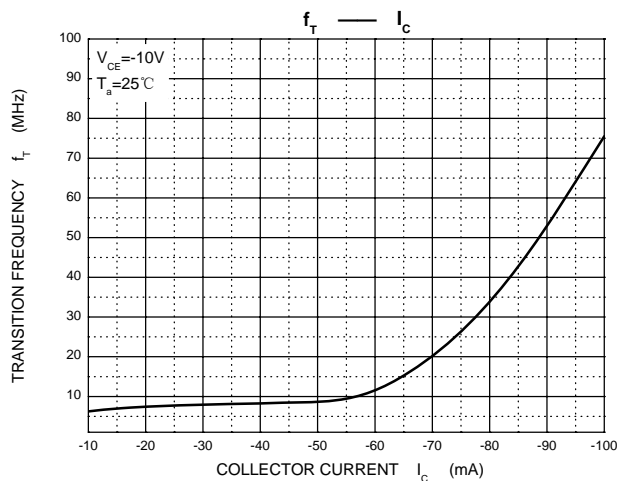
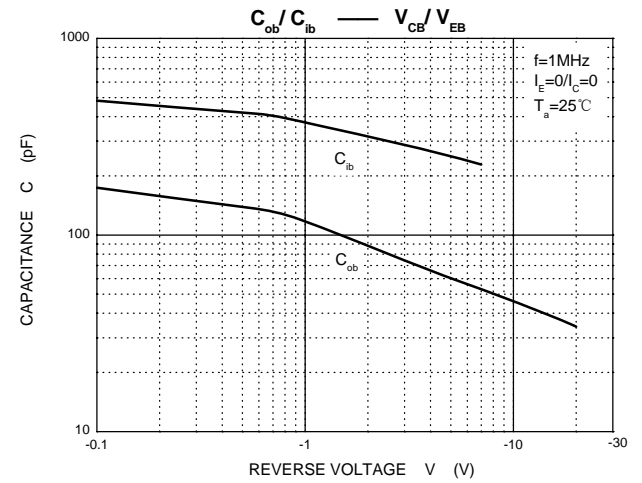
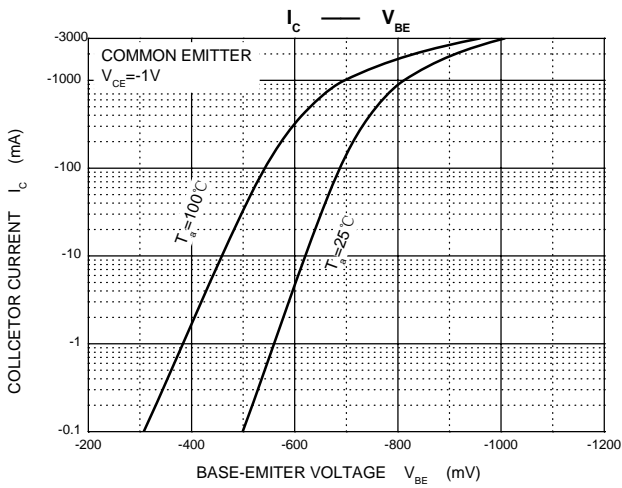
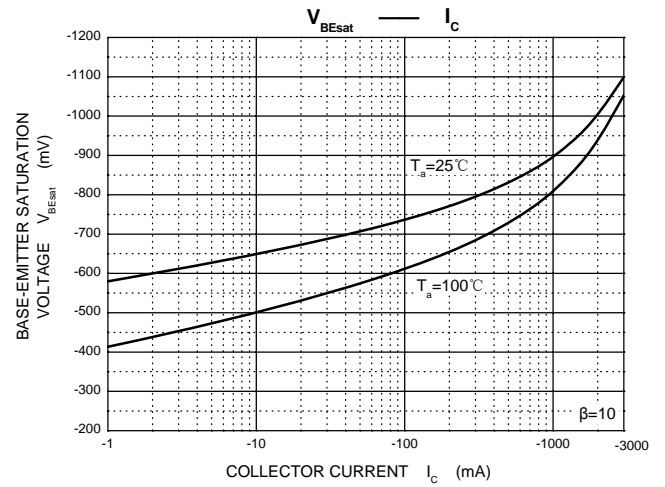
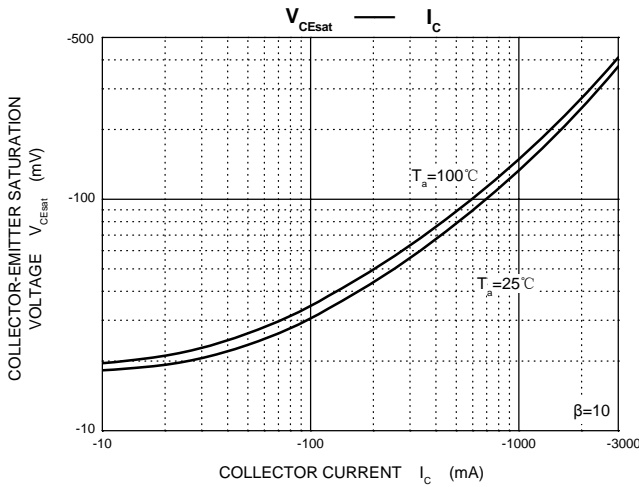
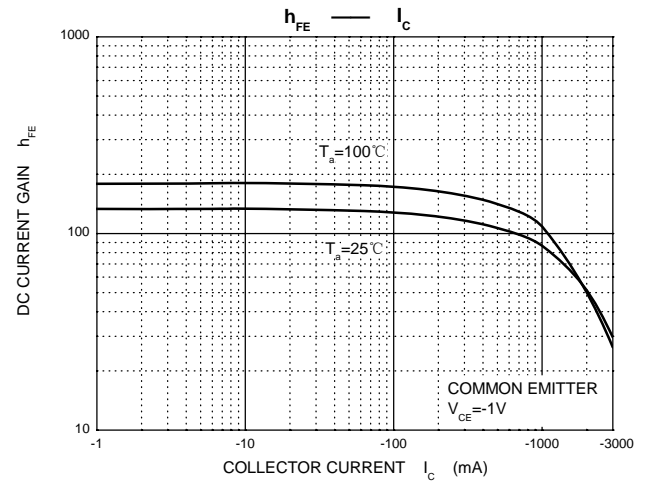
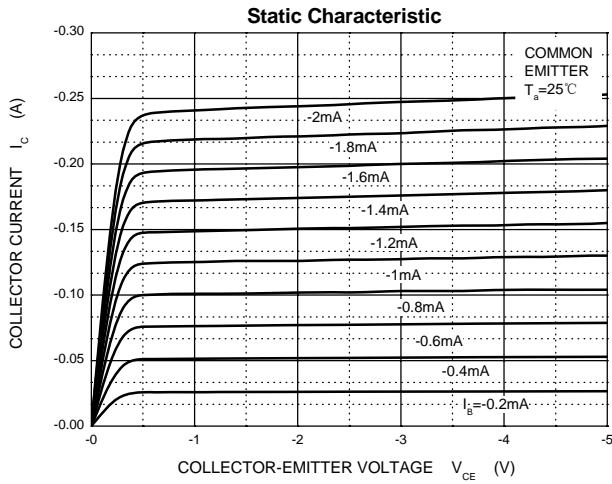

# TO-126 Package Outline Dimensions



Symbol	Dimensions In Millimeters		Dimensions In Inches	
	Min	Max	Min	Max
A	2.500	2.900	0.098	0.114
A1	1.100	1.500	0.043	0.059
b	0.660	0.860	0.026	0.034
b1	1.170	1.370	0.046	0.054
c	0.450	0.600	0.018	0.024
D	7.400	7.800	0.291	0.307
E	10.600	11.000	0.417	0.433
e	2.290 TYP		0.090 TYP	
e1	4.480	4.680	0.176	0.184
h	0.000	0.300	0.000	0.012
L	15.300	15.700	0.602	0.618
L1	2.100	2.300	0.083	0.091
P	3.900	4.100	0.154	0.161
Φ	3.000	3.200	0.118	0.126