



SOT-323 Plastic-Encapsulate Transistors

KTC4077 TRANSISTOR (NPN)

FEATURES

- High DC Current Gain
- Complementary to KTA2017
- High Voltage
- Excellent h_{FE} Linearity
- Low Noise

APPLICATIONS

- General Purpose Amplification

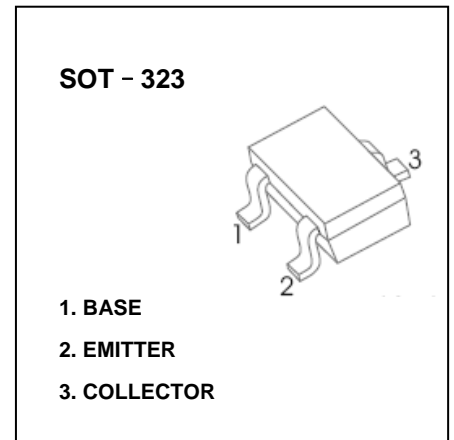

MAXIMUM RATINGS ($T_a=25^\circ\text{C}$ unless otherwise noted)

| Symbol | Parameter | Value | Unit |
|-----------------|--|----------|---------------------------|
| V_{CBO} | Collector-Base Voltage | 120 | V |
| V_{CEO} | Collector-Emitter Voltage | 120 | V |
| V_{EBO} | Emitter-Base Voltage | 5 | V |
| I_C | Collector Current | 100 | mA |
| I_B | Base Current | 20 | mA |
| P_C | Collector Power Dissipation | 100 | mW |
| $R_{\theta JA}$ | Thermal Resistance from Junction to Ambient | 1250 | $^\circ\text{C}/\text{W}$ |
| T_J, T_{stg} | Operation Junction and Storage Temperature Range | -55~+150 | $^\circ\text{C}$ |

ELECTRICAL CHARACTERISTICS ($T_a=25^\circ\text{C}$ unless otherwise specified)

| Parameter | Symbol | Test conditions | Min | Typ | Max | Unit |
|--------------------------------------|---------------|---|-----|-----|-----|------|
| Collector-base breakdown voltage | $V_{(BR)CBO}$ | $I_C=100\mu\text{A}, I_E=0$ | 120 | | | V |
| Collector-emitter breakdown voltage | $V_{(BR)CEO}$ | $I_C=1\text{mA}, I_B=0$ | 120 | | | V |
| Emitter-base breakdown voltage | $V_{(BR)EBO}$ | $I_E=10\mu\text{A}, I_C=0$ | 5 | | | V |
| Collector cut-off current | I_{CBO} | $V_{CB}=120\text{V}, I_E=0$ | | | 100 | nA |
| Emitter cut-off current | I_{EBO} | $V_{EB}=5\text{V}, I_C=0$ | | | 100 | nA |
| DC current gain | h_{FE} | $V_{CE}=6\text{V}, I_C=2\text{mA}$ | 200 | | 700 | |
| Collector-emitter saturation voltage | $V_{CE(sat)}$ | $I_C=10\text{mA}, I_B=1\text{mA}$ | | | 0.3 | V |
| Transition frequency | f_T | $V_{CE}=6\text{V}, I_C=1\text{mA}$ | | 100 | | MHz |
| Collector output capacitance | C_{ob} | $V_{CB}=10\text{V}, I_E=0, f=1\text{MHz}$ | | 4 | | pF |
| Noise Figure | NF | $V_{CE}=6\text{V}, I_C=0.1\text{mA}, f=1\text{kHz}, R_g=10\text{k}\Omega$ | | | 10 | dB |

CLASSIFICATION OF h_{FE}

| RANK | GR | BL |
|---------|---------|---------|
| RANGE | 200-400 | 350-700 |
| MARKING | DGR | DBL |

Typical Characteristics

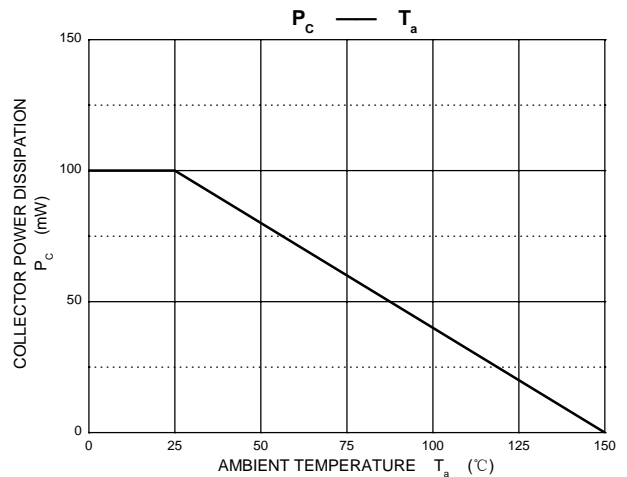
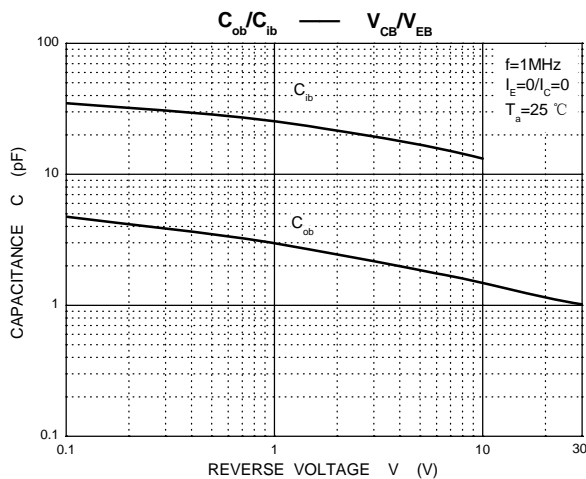
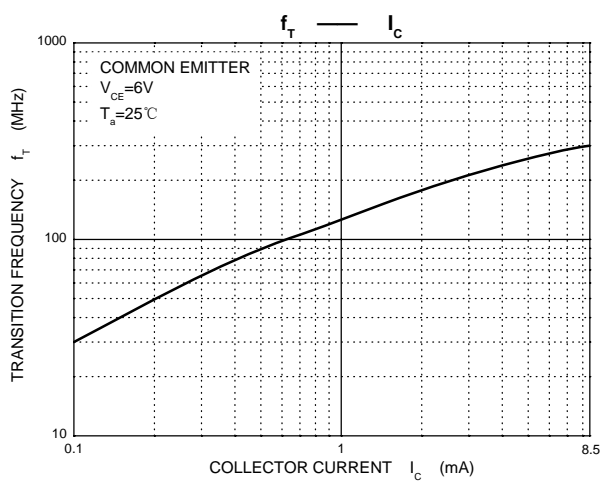
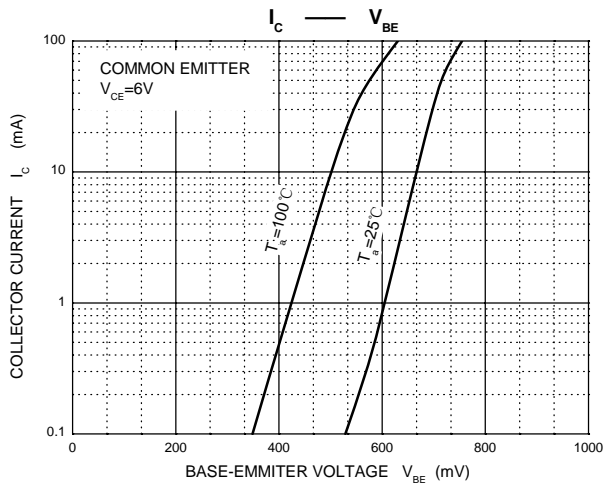
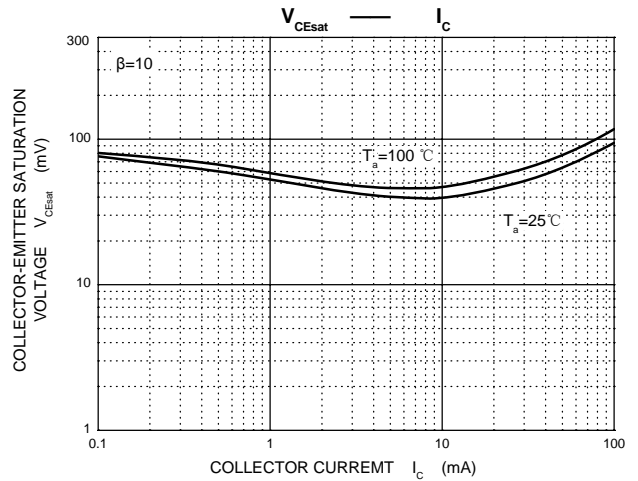
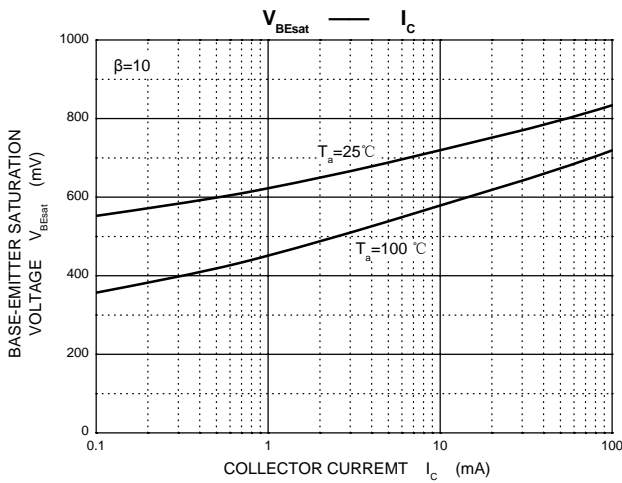
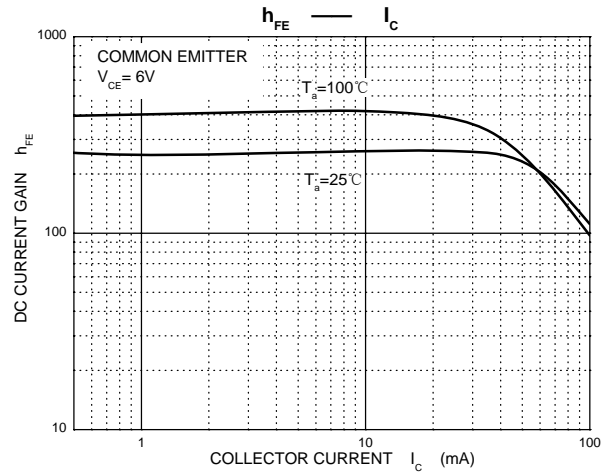
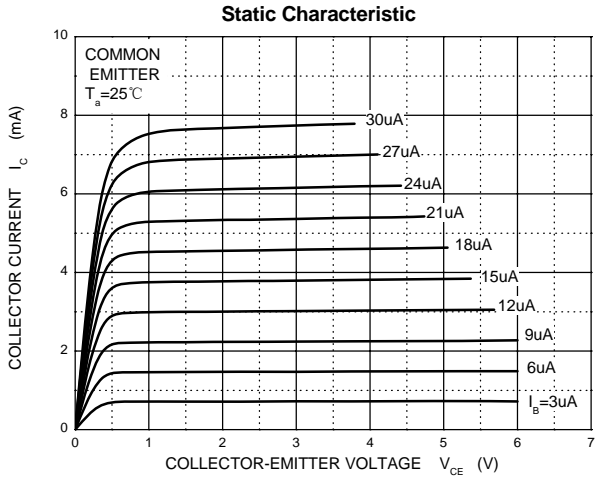

SOT-323 Package Outline Dimensions

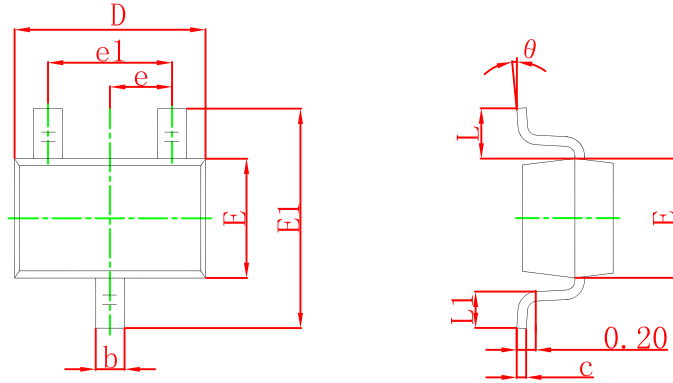

| Symbol | Dimensions In Millimeters | | Dimensions In Inches | |
|----------|---------------------------|-------|----------------------|-------|
| | Min | Max | Min | Max |
| A | 0.900 | 1.100 | 0.035 | 0.043 |
| A1 | 0.000 | 0.100 | 0.000 | 0.004 |
| A2 | 0.900 | 1.000 | 0.035 | 0.039 |
| b | 0.200 | 0.400 | 0.008 | 0.016 |
| c | 0.080 | 0.150 | 0.003 | 0.006 |
| D | 2.000 | 2.200 | 0.079 | 0.087 |
| E | 1.150 | 1.350 | 0.045 | 0.053 |
| E1 | 2.150 | 2.450 | 0.085 | 0.096 |
| e | 0.650 TYP | | 0.026 TYP | |
| e1 | 1.200 | 1.400 | 0.047 | 0.055 |
| L | 0.525 REF | | 0.021 REF | |
| L1 | 0.260 | 0.460 | 0.010 | 0.018 |
| θ | 0° | 8° | 0° | 8° |

SOT-323 Suggested Pad Layout

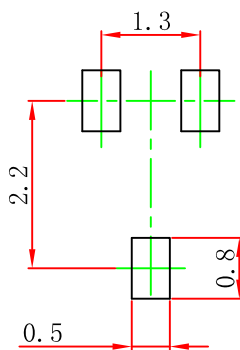

- Note:
1. Controlling dimension: in millimeters.
 2. General tolerance: ± 0.05 mm.
 3. The pad layout is for reference purposes only.

SOT-323 Tape and Reel

SOT-323 Embossed Carrier Tape

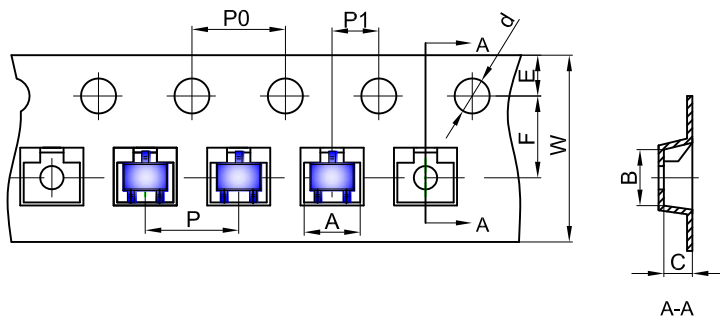

Packaging Description:
 SOT-323 parts are shipped in tape. The carrier tape is made from a dissipative (carbon filled) polycarbonate resin. The cover tape is a multilayer film (Heat Activated Adhesive in nature) primarily composed of polyester film, adhesive layer, sealant, and anti-static sprayed agent. These reeled parts in standard option are shipped with 3,000 units per 7" or 17.8cm diameter reel. The reels are clear in color and is made of polystyrene plastic (anti-static coated).

| Dimensions are in millimeter | | | | | | | | | | |
|------------------------------|------|------|------|-------|------|------|------|------|------|------|
| Pkg type | A | B | C | d | E | F | P0 | P | P1 | W |
| SOT-323 | 2.25 | 2.55 | 1.19 | Ø1.55 | 1.75 | 3.50 | 4.00 | 4.00 | 2.00 | 8.00 |

SOT-323 Tape Leader and Trailer

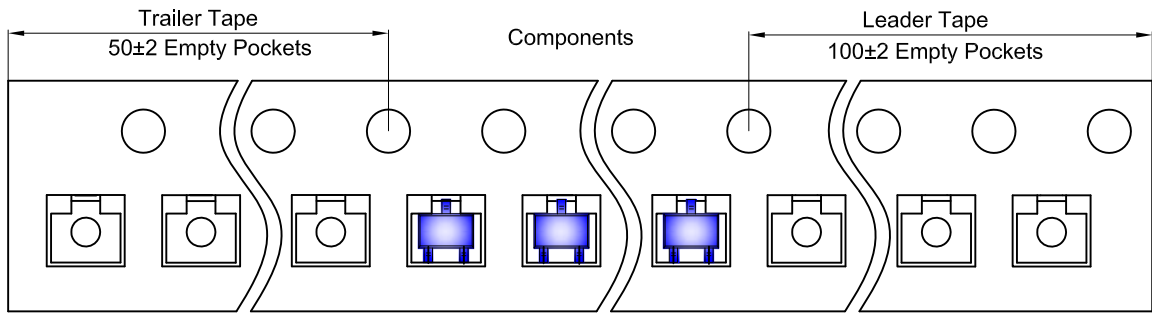

SOT-323 Reel

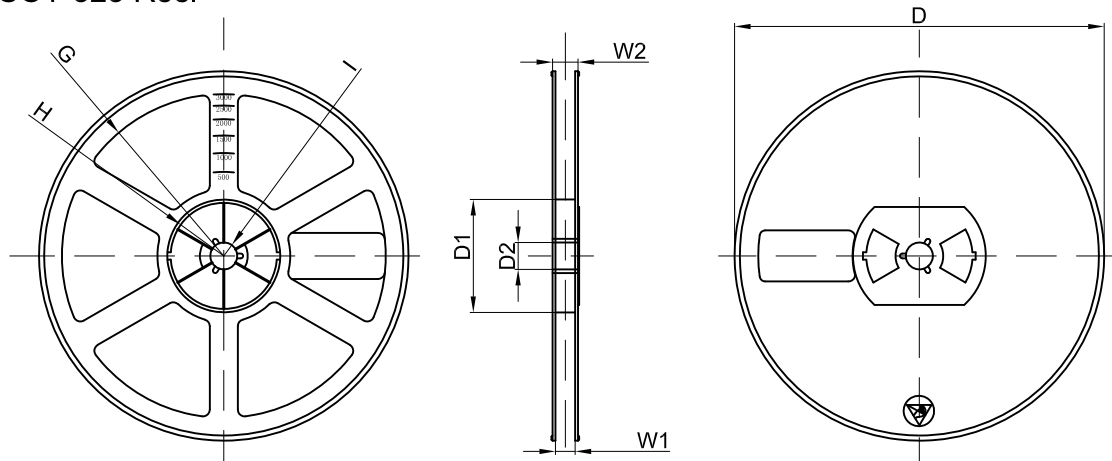

| Dimensions are in millimeter | | | | | | | | |
|------------------------------|---------|-------|-------|--------|--------|-------|------|-------|
| Reel Option | D | D1 | D2 | G | H | I | W1 | W2 |
| 7" Dia | Ø178.00 | 54.40 | 13.00 | R78.00 | R25.60 | R6.50 | 9.50 | 12.30 |

| REEL | Reel Size | Box | Box Size(mm) | Carton | Carton Size(mm) | G.W.(kg) |
|----------|-----------|------------|--------------|-------------|-----------------|----------|
| 3000 pcs | 7 inch | 45,000 pcs | 203×203×195 | 180,000 pcs | 438×438×220 | |