



SOT-323 Plastic-Encapsulate Transistors

MMST5551 TRANSISTOR (NPN)

FEATURES

- Complementary to MMST5401
- Small Surface Mount Package
- Ideal for Medium Power Amplification and Switching

MARKING:K4N

MAXIMUM RATINGS ($T_a=25^{\circ}\text{C}$ unless otherwise noted)

Symbol	Parameter	Value	Unit
V_{CBO}	Collector-Base Voltage	180	V
V_{CEO}	Collector-Emitter Voltage	160	V
V_{EBO}	Emitter-Base Voltage	6	V
I_C	Collector Current	600	mA
P_C	Collector Power Dissipation	200	mW
$R_{\theta JA}$	Thermal Resistance From Junction To Ambient	625	$^{\circ}\text{C}/\text{W}$
T_J, T_{stg}	Operation Junction and Storage Temperature Range	-55~+150	$^{\circ}\text{C}$

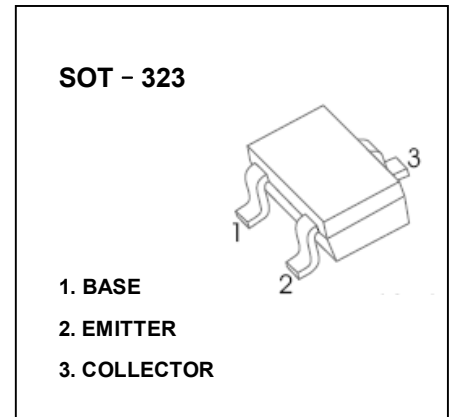

ELECTRICAL CHARACTERISTICS ($T_a=25^{\circ}\text{C}$ unless otherwise specified)

Parameter	Symbol	Test conditions	Min	Typ	Max	Unit
Collector-base breakdown voltage	$V_{(BR)CBO}$	$I_C=100\mu\text{A}, I_E=0$	180			V
Collector-emitter breakdown voltage	$V_{(BR)CEO}^*$	$I_C=1\text{mA}, I_B=0$	160			V
Emitter-base breakdown voltage	$V_{(BR)EBO}$	$I_E=10\mu\text{A}, I_C=0$	6			V
Collector cut-off current	I_{CBO}	$V_{CB}=120\text{V}, I_E=0$			50	nA
Emitter cut-off current	I_{EBO}	$V_{EB}=4\text{V}, I_C=0$			50	nA
DC current gain	h_{FE}	$V_{CE}=5\text{V}, I_C=1\text{mA}$	80			
		$V_{CE}=5\text{V}, I_C=10\text{mA}$	100		300	
		$V_{CE}=5\text{V}, I_C=50\text{mA}$	30			
Collector-emitter saturation voltage	$V_{CE(sat)}$	$I_C=50\text{mA}, I_B=5\text{mA}$			0.2	V
		$I_C=10\text{mA}, I_B=1\text{mA}$			0.15	V
Base-emitter saturation voltage	$V_{BE(sat)}$	$I_C=50\text{mA}, I_B=5\text{mA}$			1	V
		$I_C=10\text{mA}, I_B=1\text{mA}$			1	V
Transition frequency	f_T	$V_{CE}=10\text{V}, I_C=10\text{mA}, f=100\text{MHz}$	100		300	MHz
Collector output capacitance	C_{ob}	$V_{CB}=10\text{V}, I_E=0, f=1\text{MHz}$			6	pF

*Pulse test: pulse width $\leq 300\mu\text{s}$, duty cycles $\leq 2.0\%$.

Typical Characteristics

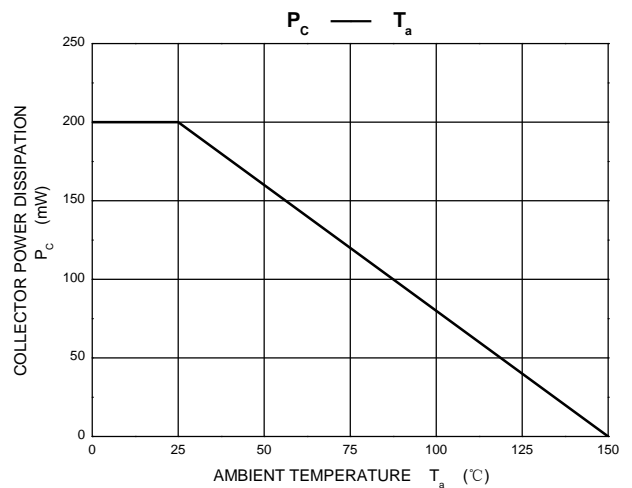
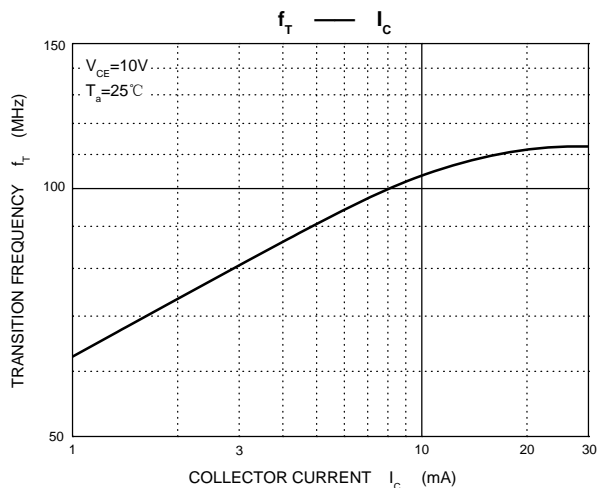
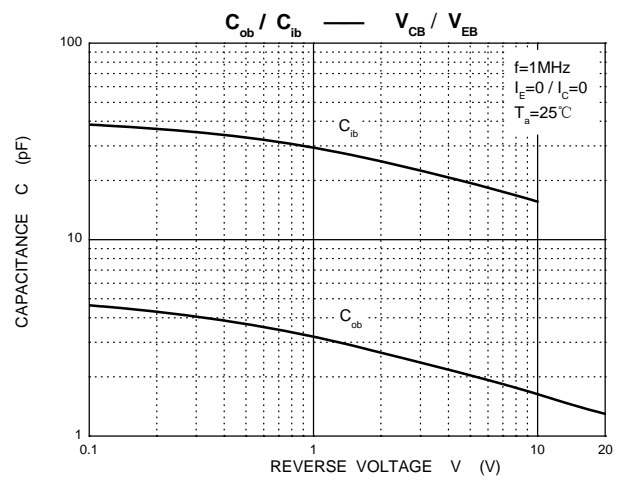
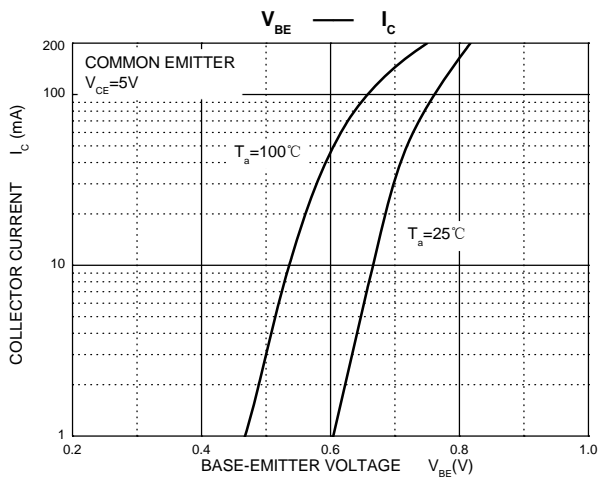
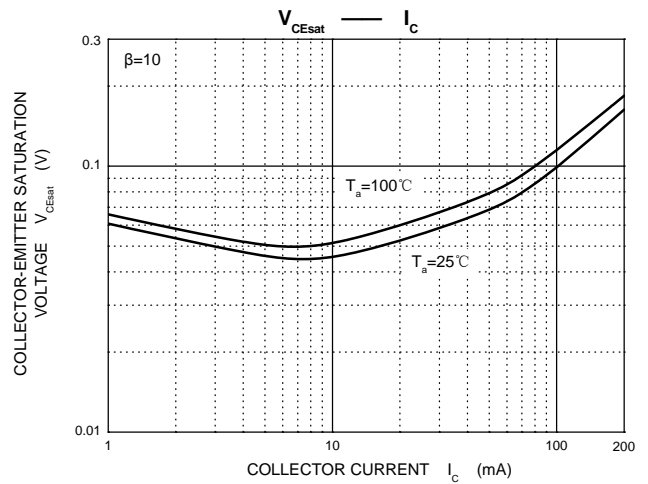
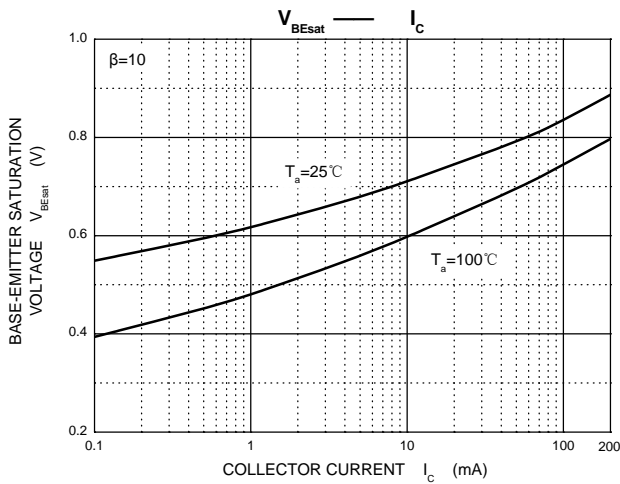
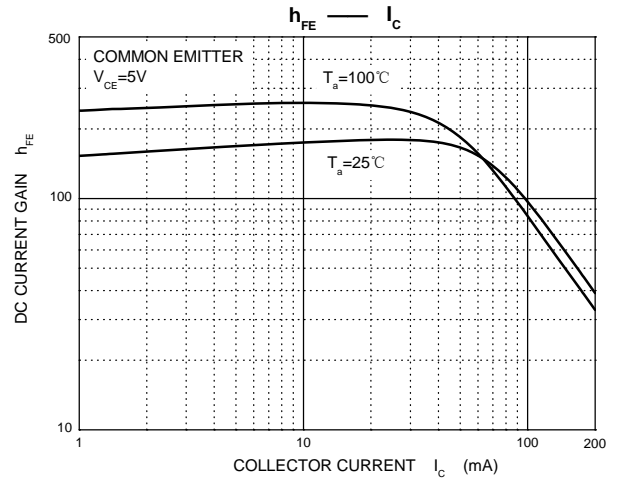
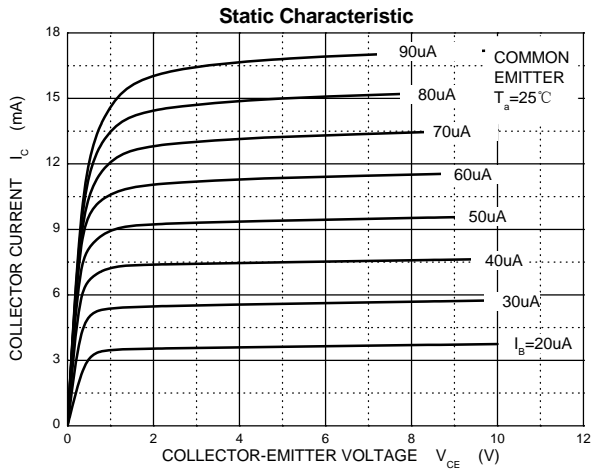

SOT-323 Package Outline Dimensions

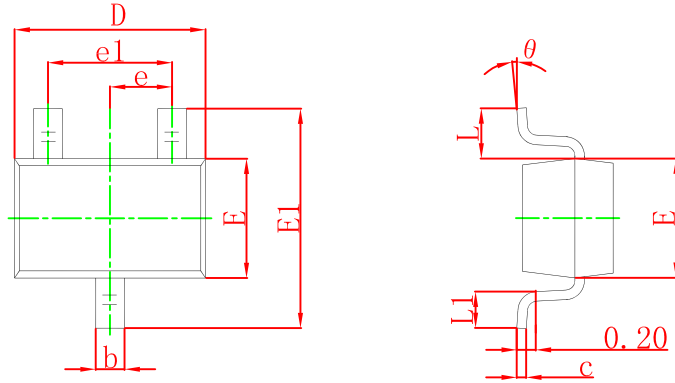

Symbol	Dimensions In Millimeters		Dimensions In Inches	
	Min	Max	Min	Max
A	0.900	1.100	0.035	0.043
A1	0.000	0.100	0.000	0.004
A2	0.900	1.000	0.035	0.039
b	0.200	0.400	0.008	0.016
c	0.080	0.150	0.003	0.006
D	2.000	2.200	0.079	0.087
E	1.150	1.350	0.045	0.053
E1	2.150	2.450	0.085	0.096
e	0.650 TYP		0.026 TYP	
e1	1.200	1.400	0.047	0.055
L	0.525 REF		0.021 REF	
L1	0.260	0.460	0.010	0.018
θ	0°	8°	0°	8°

SOT-323 Suggested Pad Layout

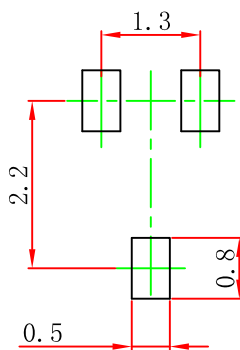

- Note:
1. Controlling dimension: in millimeters.
 2. General tolerance: ± 0.05 mm.
 3. The pad layout is for reference purposes only.

SOT-323 Tape and Reel

SOT-323 Embossed Carrier Tape

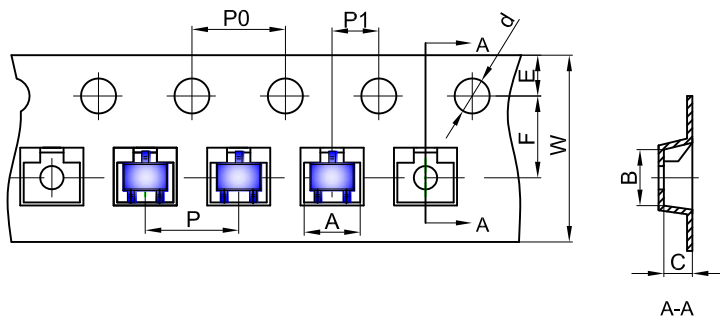

Packaging Description:
 SOT-323 parts are shipped in tape. The carrier tape is made from a dissipative (carbon filled) polycarbonate resin. The cover tape is a multilayer film (Heat Activated Adhesive in nature) primarily composed of polyester film, adhesive layer, sealant, and anti-static sprayed agent. These reeled parts in standard option are shipped with 3,000 units per 7" or 17.8cm diameter reel. The reels are clear in color and is made of polystyrene plastic (anti-static coated).

Dimensions are in millimeter										
Pkg type	A	B	C	d	E	F	P0	P	P1	W
SOT-323	2.25	2.55	1.19	Ø1.55	1.75	3.50	4.00	4.00	2.00	8.00

SOT-323 Tape Leader and Trailer

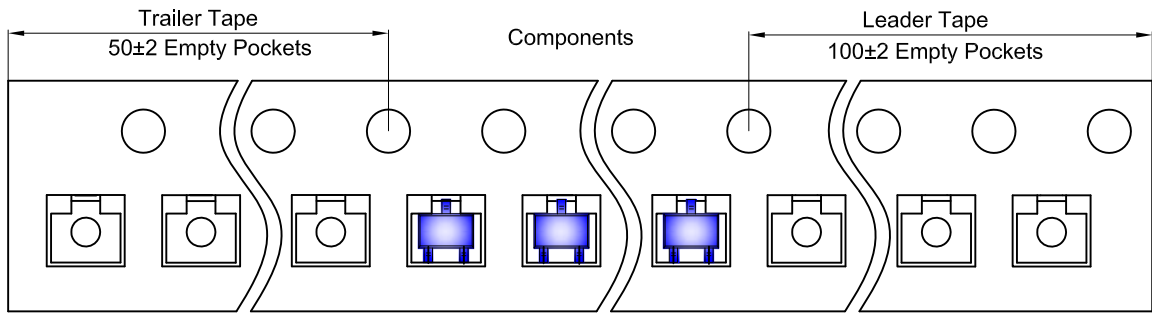

SOT-323 Reel

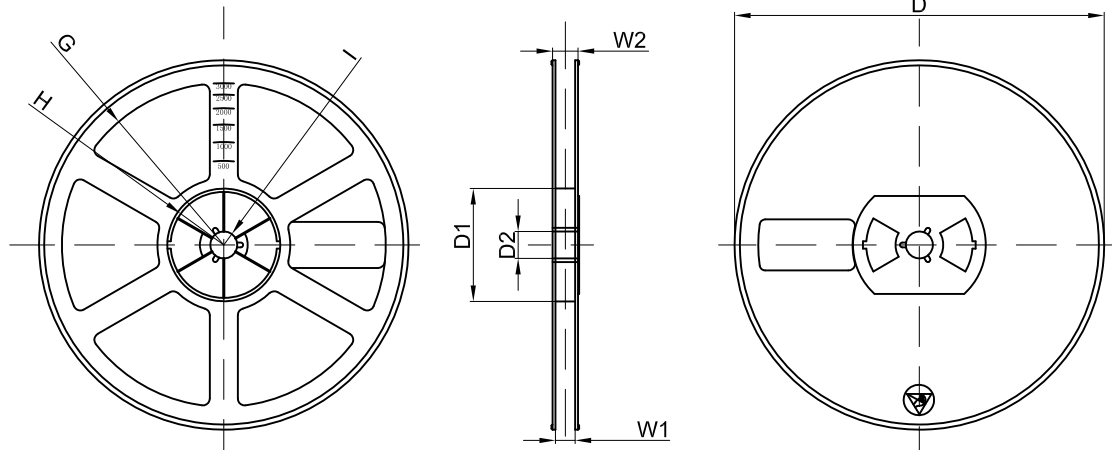

Dimensions are in millimeter								
Reel Option	D	D1	D2	G	H	I	W1	W2
7" Dia	Ø178.00	54.40	13.00	R78.00	R25.60	R6.50	9.50	12.30

REEL	Reel Size	Box	Box Size(mm)	Carton	Carton Size(mm)	G.W.(kg)
3000 pcs	7 inch	45,000 pcs	203×203×195	180,000 pcs	438×438×220	