



SOT-323 Plastic-Encapsulate Transistors

MMSTA42 TRANSISTOR (NPN)

FEATURES

- High Breakdown Voltage
- Low Collector-Emitter Saturation Voltage
- Complementary to MMSTA92(PNP)

MARKING:K3M

MAXIMUM RATINGS (T_a=25°C unless otherwise noted)

Symbol	Parameter	Value	Unit
V _{CB0}	Collector-Base Voltage	300	V
V _{CE0}	Collector-Emitter Voltage	300	V
V _{EBO}	Emitter-Base Voltage	5	V
I _C	Collector Current -Continuous	0.2	A
I _{CM}	Collector Current -Pulsed	0.5	A
P _C	Collector Power Dissipation	0.3	W
R _{θJA}	Thermal Resistance from Junction to Ambient	417	°C/W
T _J , T _{stg}	Operation Junction and Storage Temperature Range	-55-150"	°C

SOT-323

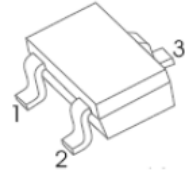

1. BASE
2. EMITTER
3. COLLECTOR"

ELECTRICAL CHARACTERISTICS (T_a=25°C unless otherwise specified)

Parameter	Symbol	Test conditions	Min	Typ	Max	Unit
Collector-base breakdown voltage	V _{(BR)CBO}	I _C =100μA, I _E =0	300			V
Collector-emitter breakdown voltage	V _{(BR)CEO}	I _C =1mA, I _B =0	300			V
Emitter-base breakdown voltage	V _{(BR)EBO}	I _E =100μA, I _C =0	5			V
Collector cut-off current	I _{CBO}	V _{CB} =200V, I _E =0			0.25	μA
Emitter cut-off current	I _{EBO}	V _{EB} =5V, I _C =0			0.1	μA
DC current gain	h _{FE(1)}	V _{CE} =10V, I _C =1mA	60			
	h _{FE(2)}	V _{CE} =10V, I _C =10mA	100		200	
	h _{FE(3)}	V _{CE} =10V, I _C =30mA	75			
Collector-emitter saturation voltage	V _{CE(sat)}	I _C =20mA, I _B =2mA			0.2	V
Base-emitter saturation voltage	V _{BE(sat)}	I _C =20mA, I _B =2mA			0.9	V
Transition frequency	f _T	V _{CE} =20V, I _C =10mA, f=30MHz	50			MHz

Typical Characteristics

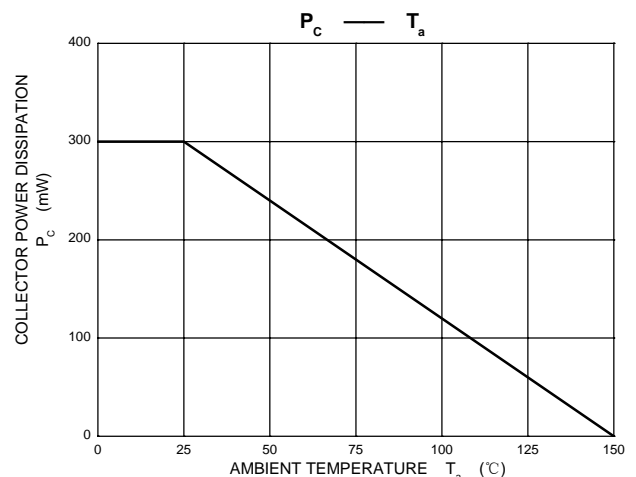
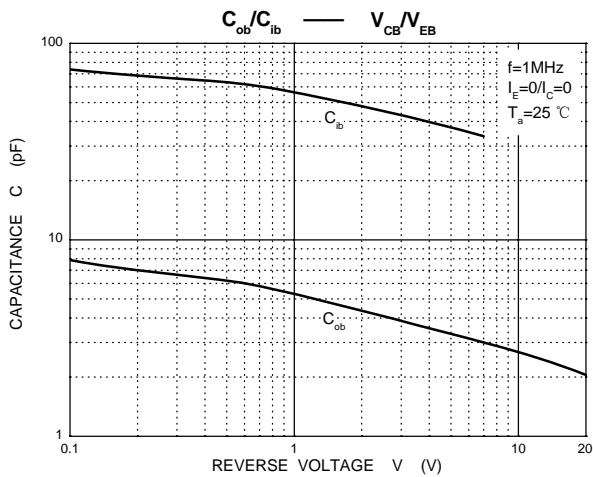
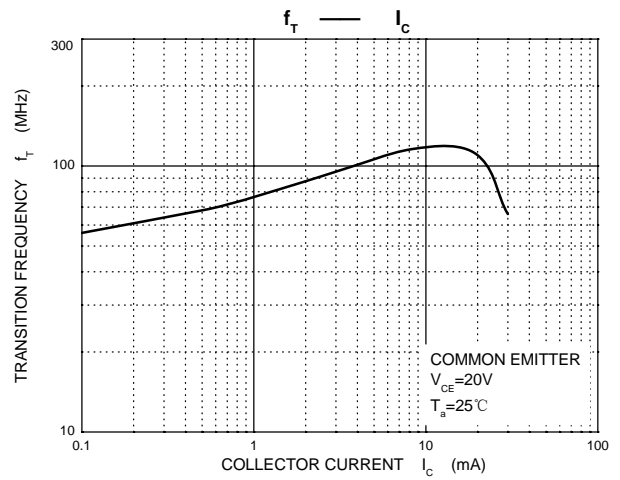
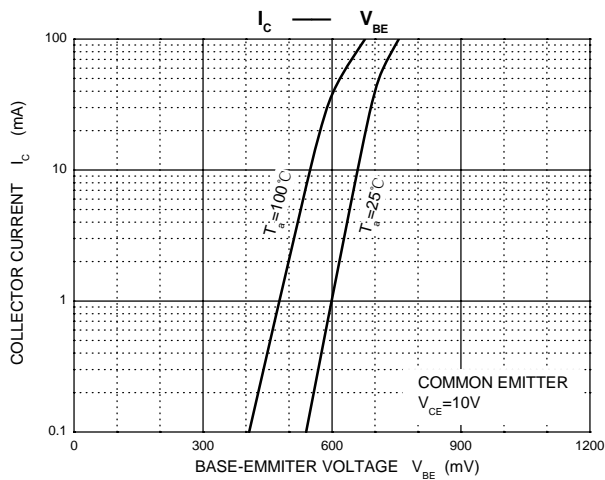
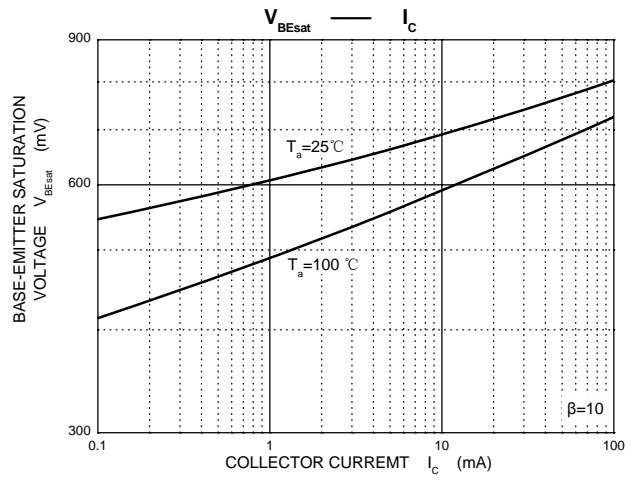
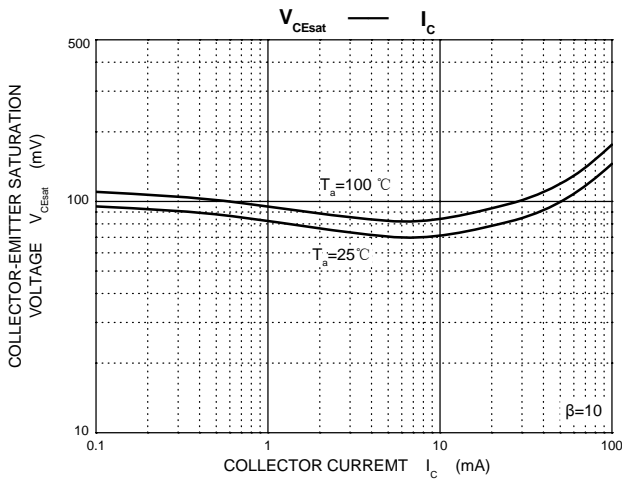
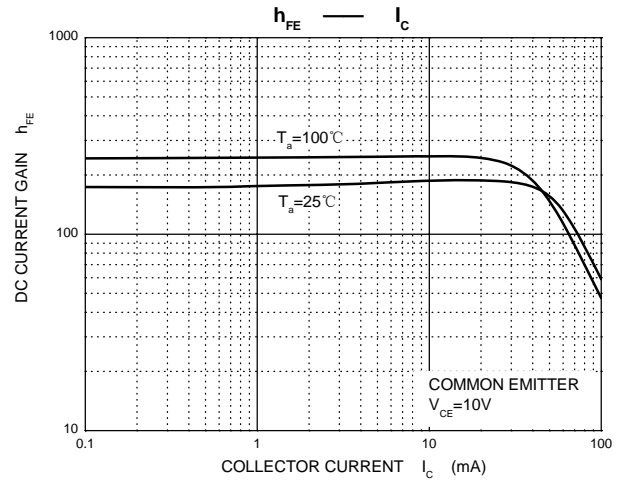
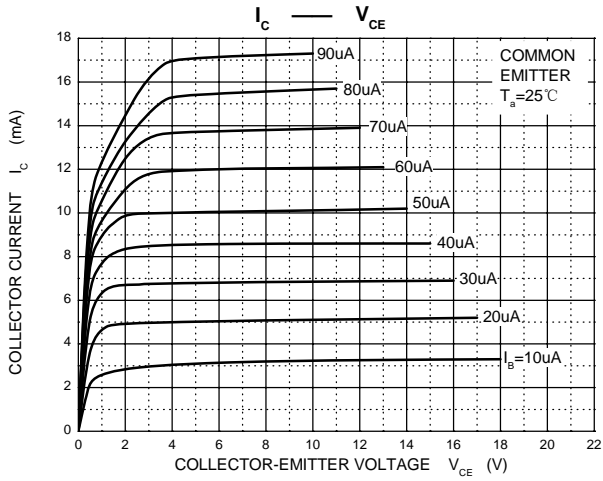

SOT-323 Package Outline Dimensions

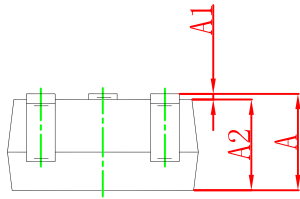
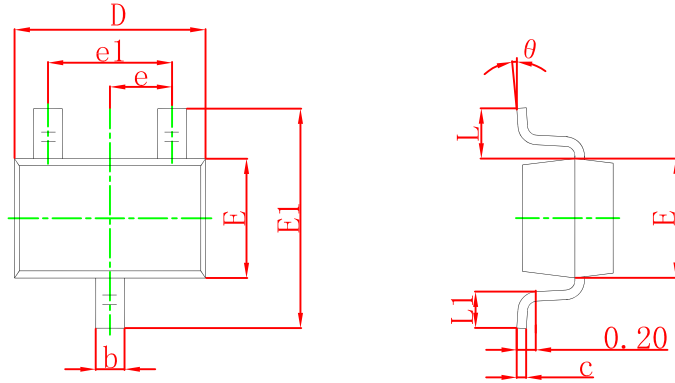

Symbol	Dimensions In Millimeters		Dimensions In Inches	
	Min	Max	Min	Max
A	0.900	1.100	0.035	0.043
A1	0.000	0.100	0.000	0.004
A2	0.900	1.000	0.035	0.039
b	0.200	0.400	0.008	0.016
c	0.080	0.150	0.003	0.006
D	2.000	2.200	0.079	0.087
E	1.150	1.350	0.045	0.053
E1	2.150	2.450	0.085	0.096
e	0.650 TYP		0.026 TYP	
e1	1.200	1.400	0.047	0.055
L	0.525 REF		0.021 REF	
L1	0.260	0.460	0.010	0.018
θ	0°	8°	0°	8°

SOT-323 Suggested Pad Layout

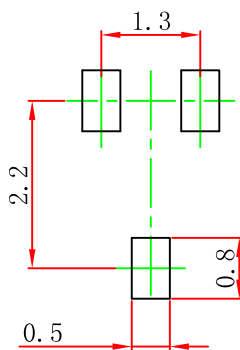

Note:

1. Controlling dimension: in millimeters.
2. General tolerance: ± 0.05 mm.
3. The pad layout is for reference purposes only.

SOT-323 Tape and Reel

SOT-323 Embossed Carrier Tape

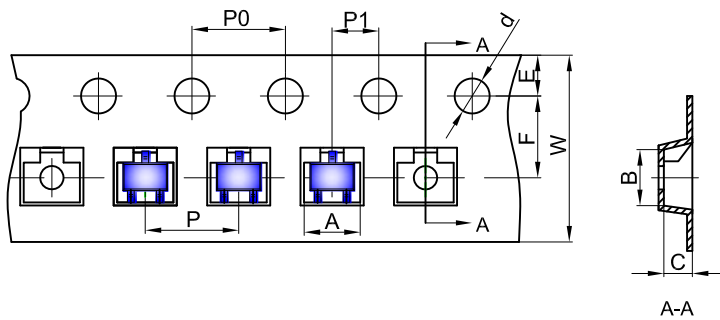

Packaging Description:
 SOT-323 parts are shipped in tape. The carrier tape is made from a dissipative (carbon filled) polycarbonate resin. The cover tape is a multilayer film (Heat Activated Adhesive in nature) primarily composed of polyester film, adhesive layer, sealant, and anti-static sprayed agent. These reeled parts in standard option are shipped with 3,000 units per 7" or 17.8cm diameter reel. The reels are clear in color and is made of polystyrene plastic (anti-static coated).

Dimensions are in millimeter										
Pkg type	A	B	C	d	E	F	P0	P	P1	W
SOT-323	2.25	2.55	1.19	Ø1.55	1.75	3.50	4.00	4.00	2.00	8.00

SOT-323 Tape Leader and Trailer

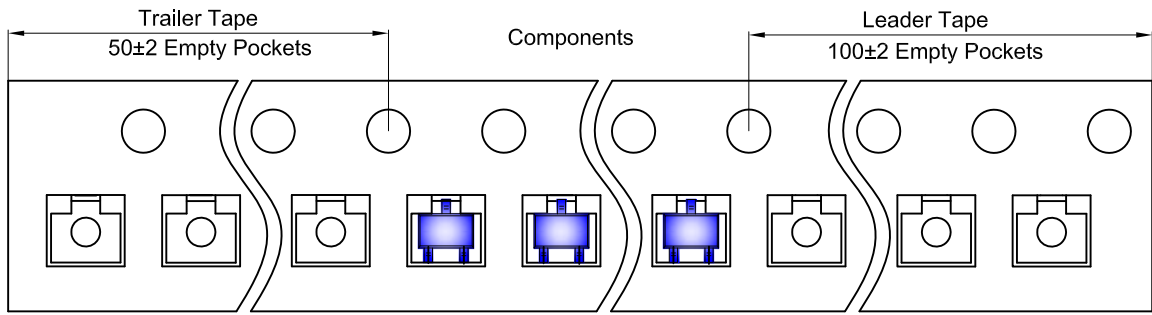

SOT-323 Reel

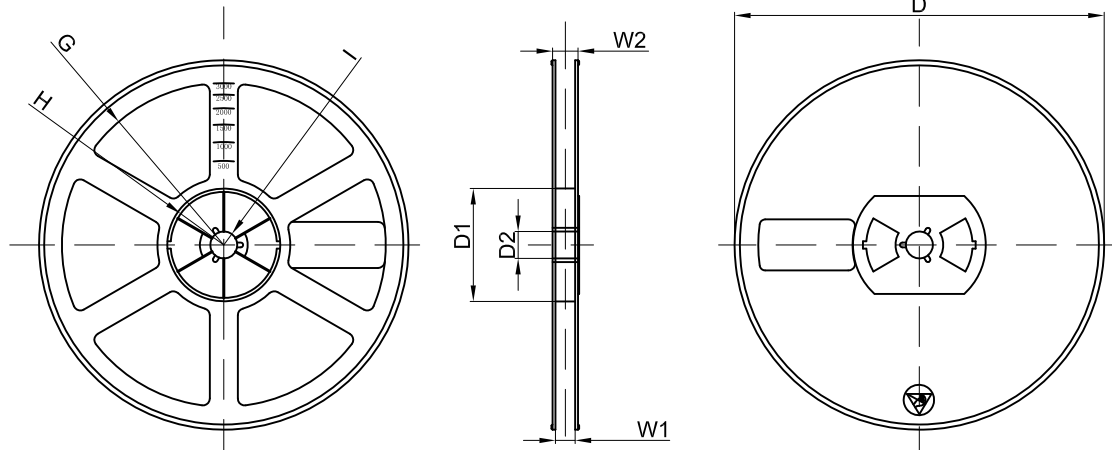

Dimensions are in millimeter								
Reel Option	D	D1	D2	G	H	I	W1	W2
7" Dia	Ø178.00	54.40	13.00	R78.00	R25.60	R6.50	9.50	12.30

REEL	Reel Size	Box	Box Size(mm)	Carton	Carton Size(mm)	G.W.(kg)
3000 pcs	7 inch	45,000 pcs	203×203×195	180,000 pcs	438×438×220	