



DONGGUAN NANJING ELECTRONICS LTD.,

## TO-92 Plastic-Encapsulate Transistors

### 2N3904 TRANSISTOR (NPN)

#### FEATURE

- NPN silicon epitaxial planar transistor for switching and Amplifier applications
- As complementary type, the PNP transistor 2N3906 is Recommended
- This transistor is also available in the SOT-23 case with the type designation MMBT3904

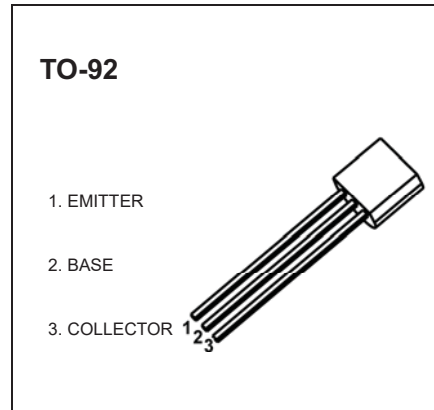

#### MARKING

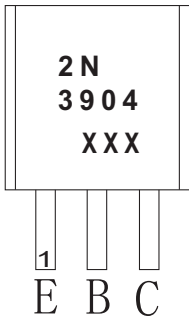

2N3904=Device code  
XXX=Code

#### Equivalent Circuit

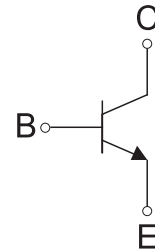

#### ORDERING INFORMATION

Part Number	Package	Packing Method	Pack Quantity
2N3904	TO-92	Bulk	1000pcs/Bag
2N3904-TA	TO-92	Tape	2000pcs/Box

#### MAXIMUM RATINGS (T<sub>a</sub>=25°C unless otherwise noted)

Symbol	Parameter	Value	Unit
V <sub>CB0</sub>	Collector-Base Voltage	60	V
V <sub>CE0</sub>	Collector-Emitter Voltage	40	V
V <sub>EB0</sub>	Emitter-Base Voltage	6	V
I <sub>C</sub>	Collector Current -Continuous	0.2	A
P <sub>C</sub>	Collector Power Dissipation	0.625	W
T <sub>J</sub> , T <sub>stg</sub>	Operation Junction and Storage Temperature Range	-55-150	°C

## ELECTRICAL CHARACTERISTICS

$T_a=25^\circ\text{C}$  unless otherwise specified

Parameter	Symbol	Test conditions	Min	Typ	Max	Unit
Collector-base breakdown voltage	$V_{(BR)CBO}$	$I_C=10\text{mA}, I_E=0$	60			V
Collector-emitter breakdown voltage	$V_{(BR)CEO}$	$I_C=1\text{mA}, I_B=0$	40			V
Emitter-base breakdown voltage	$V_{(BR)EBO}$	$I_E=10\text{mA}, I_C=0$	6			V
Collector cut-off current	$I_{CBO}$	$V_{CB}=60\text{V}, I_E=0$			0.1	$\mu\text{A}$
Collector cut-off current	$I_{CEX}$	$V_{CE}=30\text{V}, V_{EB(off)}=3\text{V}$			0.05	$\mu\text{A}$
Emitter cut-off current	$I_{EBO}$	$V_{EB}=5\text{V}, I_C=0$			0.1	$\mu\text{A}$
DC current gain	$h_{FE1}$	$V_{CE}=1\text{V}, I_C=10\text{mA}$	100		400	
	$h_{FE2}$	$V_{CE}=1\text{V}, I_C=50\text{mA}$	60			
	$h_{FE3}$	$V_{CE}=1\text{V}, I_C=100\text{mA}$	30			
Collector-emitter saturation voltage	$V_{CE(sat)}$	$I_C=50\text{mA}, I_B=5\text{mA}$			0.3	V
Base-emitter saturation voltage	$V_{BE(sat)}$	$I_C=50\text{mA}, I_B=5\text{mA}$			0.95	V
Transition frequency	$f_T$	$V_{CE}=20\text{V}, I_C=10\text{mA}, f=100\text{MHz}$	300			MHz
Delay Time	$t_d$	$V_{CC}=3\text{V}, V_{BE}=0.5\text{V},$			35	ns
Rise Time	$t_r$	$I_C=10\text{mA}, I_{B1}=1\text{mA}$			35	ns
Storage Time	$t_s$	$V_{CC}=3\text{V}, I_C=10\text{mA}$			200	ns
Fall Time	$t_f$	$I_{B1}=I_{B2}=1\text{mA}$			50	ns

### CLASSIFICATION OF $h_{FE1}$

Rank	O	Y	G
Range	100-200	200-300	300-400

# Typical Characteristics

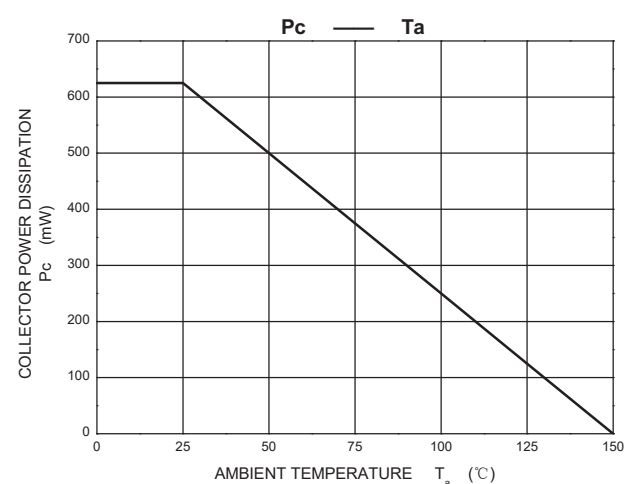
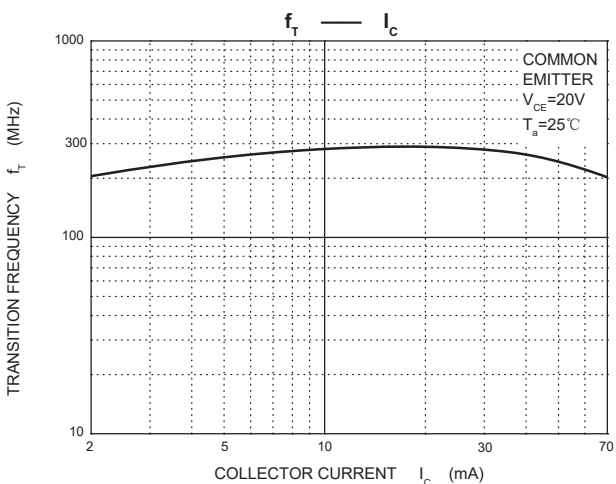
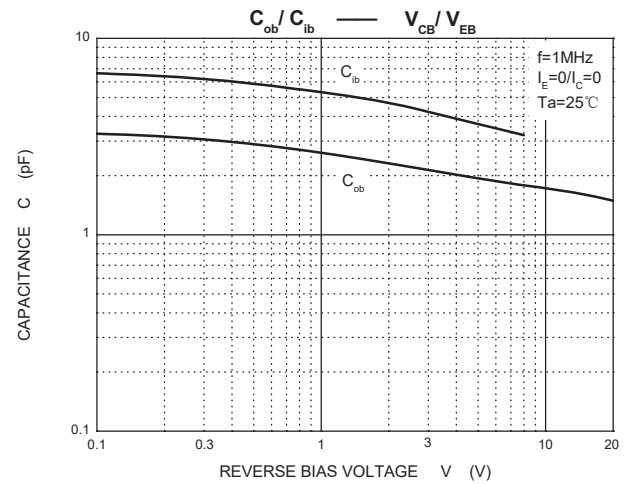
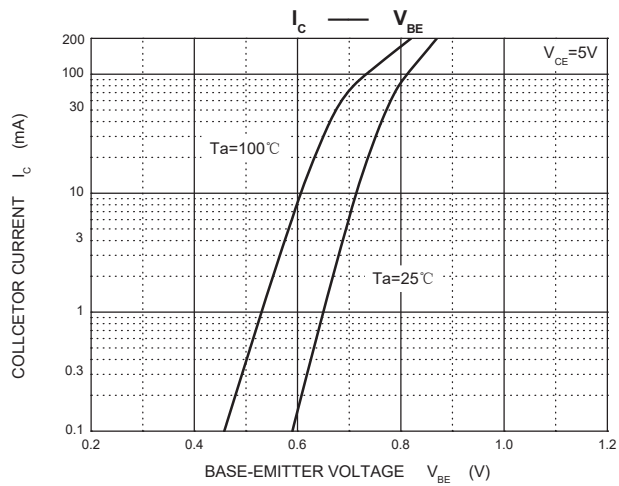
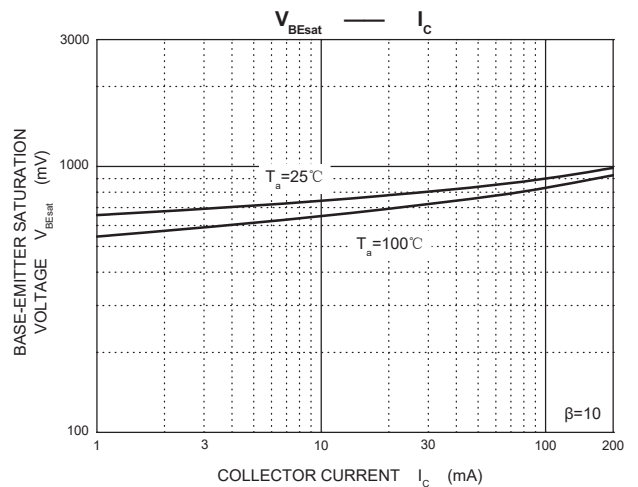
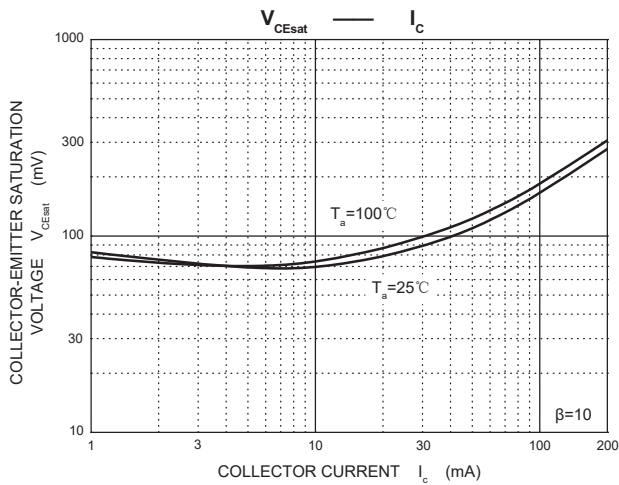
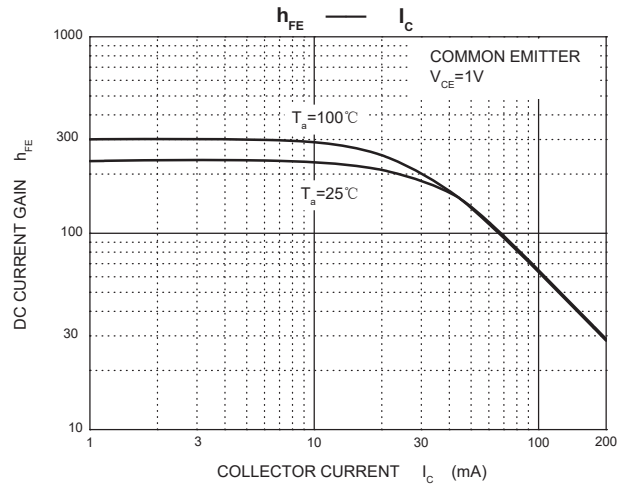
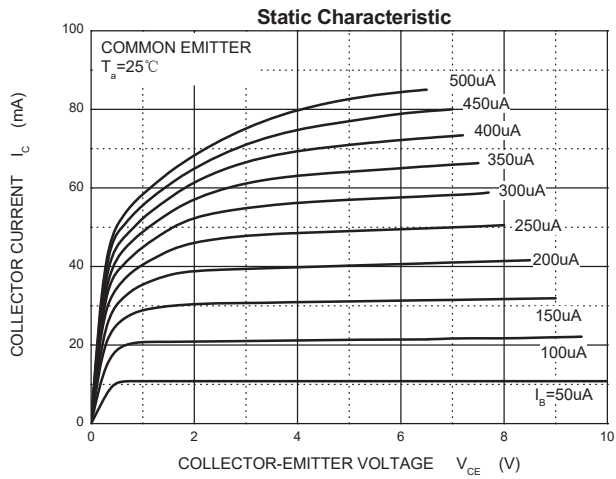

## TO-92 Package Outline Dimensions



Symbol	Dimensions In Millimeters		Dimensions In Inches	
	Min	Max	Min	Max
A	3.300	3.700	0.130	0.146
A1	1.100	1.400	0.043	0.055
b	0.380	0.550	0.015	0.022
c	0.360	0.510	0.014	0.020
D	4.300	4.700	0.169	0.185
D1	3.430		0.135	
E	4.300	4.700	0.169	0.185
e	1.270 TYP		0.050 TYP	
e1	2.440	2.640	0.096	0.104
L	14.100	14.500	0.555	0.571
Φ		1.600		0.063
h	0.000	0.380	0.000	0.015

## TO-92 Suggested Pad Layout

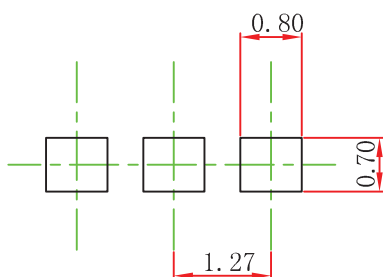

### Note:

1. Controlling dimension: in millimeters.
2. General tolerance:  $\pm 0.05\text{mm}$ .
3. The pad layout is for reference purposes only.

# TO-92 Tape and Reel



Dimensions are in millimeter								
A1	A	T	P	P0	P2	F1	F2	W
4.5	4.5	3.5	12.7	12.7	6.35	2.5	2.5	18.0
W0	W1	W2	H	H0	D0	t1	t2	ΔP
6.0	9.0	1.0 MAX.	19.0	16.0	4.0	0.4	0.2	0

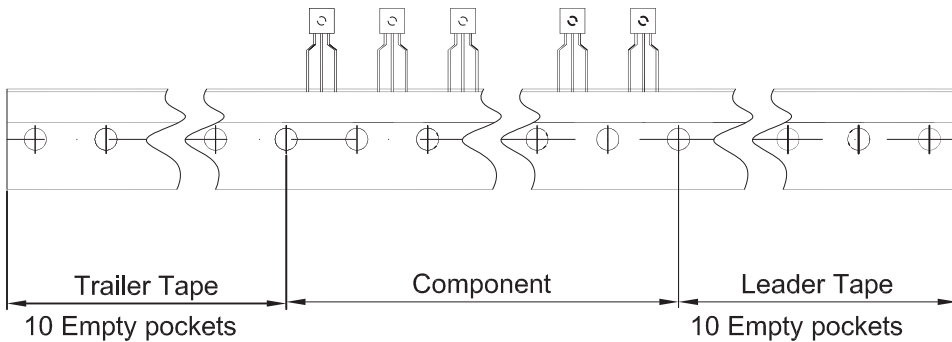

Package	Box	Box Size(mm)	Carton	Carton Size(mm)
TO-92	2000 pcs	333×162×43	20,000 pcs	350×340×250