



DONGGUAN NANJING ELECTRONICS LTD.,

TO-92 Plastic-Encapsulate Transistors

2N5832 TRANSISTOR (NPN)

FEATURES

- General Purpose Switching Application

TO – 92

1. EMITTER

2. BASE

3. COLLECTOR

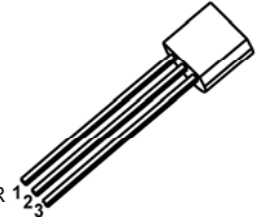

MARKING

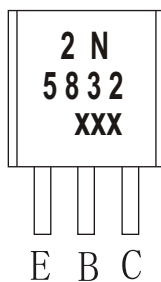

2N5832=Device code

XXX=Code

Equivalent Circuit

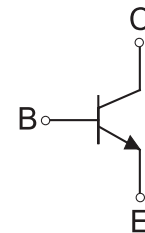

ORDERING INFORMATION

| Part Number | Package | Packing Method | Pack Quantity |
|-------------|---------|----------------|---------------|
| 2N5832 | TO-92 | Bulk | 1000pcs/Bag |
| 2N5832-TA | TO-92 | Tape | 2000pcs/Box |

MAXIMUM RATINGS ($T_a=25^{\circ}\text{C}$ unless otherwise noted)

| Symbol | Parameter | Value | Unit |
|-----------------|--|----------|-------------------------------|
| V_{CBO} | Collector-Base Voltage | 160 | V |
| V_{CEO} | Collector-Emitter Voltage | 140 | V |
| V_{EBO} | Emitter-Base Voltage | 5 | V |
| I_C | Collector Current -Continuous | 0.6 | A |
| P_D | Collector Power Dissipation | 625 | mW |
| $R_{\theta JA}$ | Thermal Resistance rom Junction to Ambient | 200 | $^{\circ}\text{C} / \text{W}$ |
| T_J, T_{stg} | Operation Junction and Storage Temperature Range | -55~+150 | $^{\circ}\text{C}$ |

ELECTRICAL CHARACTERISTICS

$T_a=25^{\circ}\text{C}$ unless otherwise specified

| Parameter | Symbol | Test conditions | Min | Typ | Max | Unit |
|--------------------------------------|---------------|--|-----|-----|------|---------------|
| Collector-base breakdown voltage | $V_{(BR)CBO}$ | $I_C=0.1\text{mA}, I_E=0$ | 160 | | | V |
| Collector-emitter breakdown voltage | $V_{(BR)CEO}$ | $I_C=1\text{mA}, I_B=0$ | 140 | | | V |
| Emitter-base breakdown voltage | $V_{(BR)EBO}$ | $I_E=0.01\text{mA}, I_C=0$ | 5 | | | V |
| Collector cut-off current | I_{CBO} | $V_{CB}=120\text{V}, I_E=0$ | | | 0.05 | μA |
| Emitter cut-off current | I_{EBO} | $V_{EB}=4\text{V}, I_C=0$ | | | 0.05 | μA |
| DC current gain | h_{FE} | $V_{CE}=5\text{V}, I_C=10\text{mA}$ | 175 | | 500 | |
| Collector-emitter saturation voltage | $V_{CE(sat)}$ | $I_C=50\text{mA}, I_B=5\text{mA}$ | | | 0.25 | V |
| Base-emitter saturation voltage | $V_{BE(sat)}$ | $I_C=50\text{mA}, I_B=5\text{mA}$ | | | 1 | V |
| Base-emitter voltage | V_{BE} | $V_{CE}=5\text{V}, I_C=1\text{mA}$ | | | 0.8 | V |
| Collector output capacitance | C_{ob} | $V_{CB}=10\text{V}, I_E=0, f=1\text{MHz}$ | | | 4 | pF |
| Transition frequency | f_T | $V_{CE}=10\text{V}, I_C=1\text{mA}, f=100\text{MHz}$ | 100 | | | MHz |

TO-92 Package Outline Dimensions

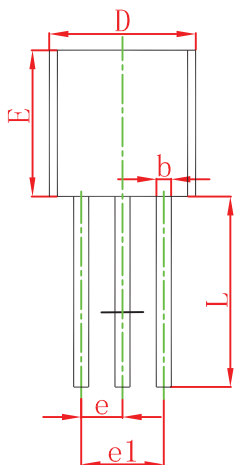
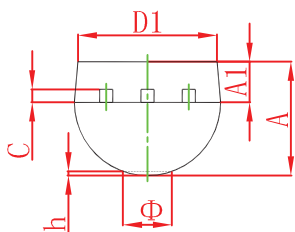

| Symbol | Dimensions In Millimeters | | Dimensions In Inches | |
|--------|---------------------------|--------|----------------------|-------|
| | Min | Max | Min | Max |
| A | 3.300 | 3.700 | 0.130 | 0.146 |
| A1 | 1.100 | 1.400 | 0.043 | 0.055 |
| b | 0.380 | 0.550 | 0.015 | 0.022 |
| c | 0.360 | 0.510 | 0.014 | 0.020 |
| D | 4.300 | 4.700 | 0.169 | 0.185 |
| D1 | 3.430 | | 0.135 | |
| E | 4.300 | 4.700 | 0.169 | 0.185 |
| e | 1.270 TYP | | 0.050 TYP | |
| e1 | 2.440 | 2.640 | 0.096 | 0.104 |
| L | 14.100 | 14.500 | 0.555 | 0.571 |
| Φ | | 1.600 | | 0.063 |
| h | 0.000 | 0.380 | 0.000 | 0.015 |

TO-92 Suggested Pad Layout

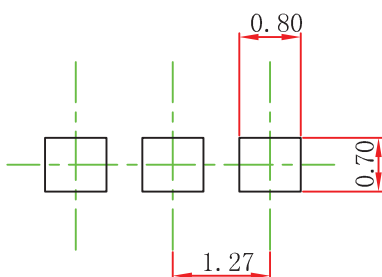

Note:

1. Controlling dimension: in millimeters.
2. General tolerance: $\pm 0.05\text{mm}$.
3. The pad layout is for reference purposes only.

TO-92 Tape and Reel

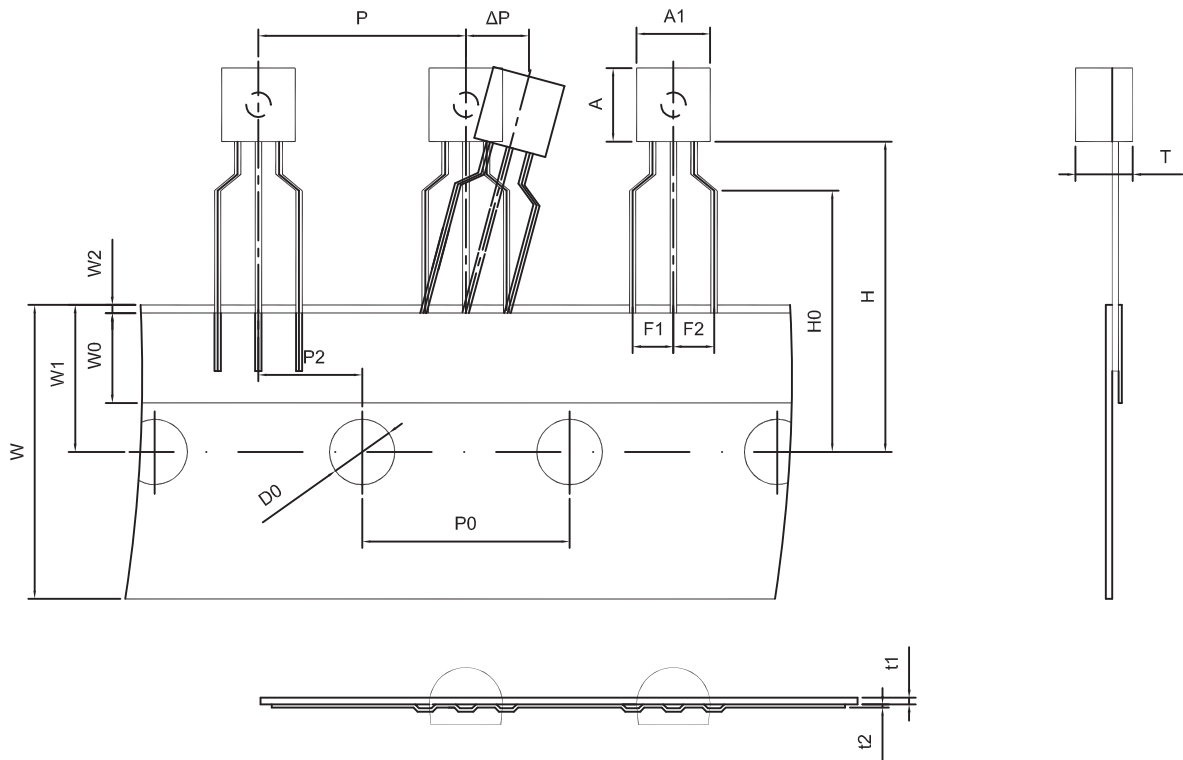

| Dimiensions are in millimeter | | | | | | | | |
|-------------------------------|-----|----------|------|------|------|-----|-----|------------|
| A1 | A | T | P | P0 | P2 | F1 | F2 | W |
| 4.5 | 4.5 | 3.5 | 12.7 | 12.7 | 6.35 | 2.5 | 2.5 | 18.0 |
| W0 | W1 | W2 | H | H0 | D0 | t1 | t2 | ΔP |
| 6.0 | 9.0 | 1.0 MAX. | 19.0 | 16.0 | 4.0 | 0.4 | 0.2 | 0 |

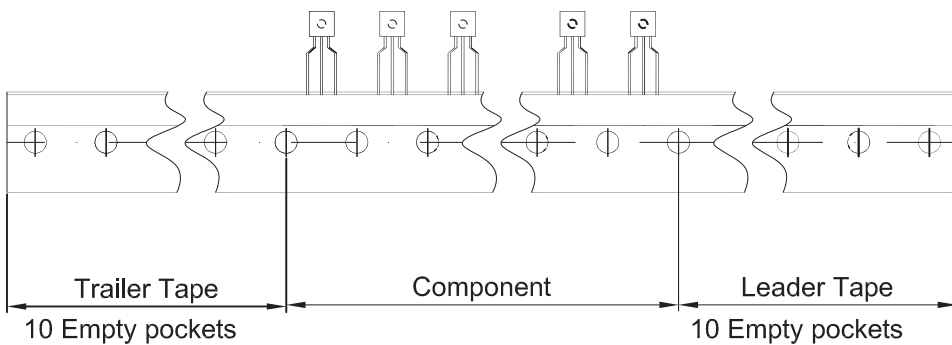

| Package | Box | Box Size(mm) | Carton | Carton Size(mm) |
|---------|----------|--------------|------------|-----------------|
| TO-92 | 2000 pcs | 333×162×43 | 20,000 pcs | 350×340×250 |