



DONGGUAN NANJING ELECTRONICS LTD.,

TO-92 Plastic-Encapsulate Transistors

2SA562 TRANSISTOR (PNP)

FEATURES

- Excellent h_{FE} Linearity

TO-92

1. EMITTER
2. COLLECTOR
3. BASE

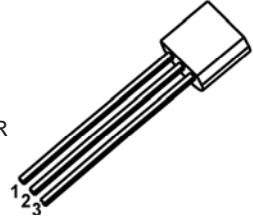

MARKING

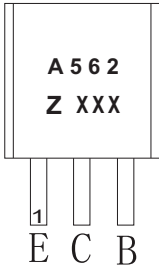

A562=Device code
Z=Rank of h_{FE}
XXX=Code

Equivalent Circuit

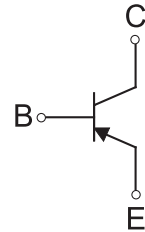

ORDERING INFORMATION

Part Number	Package	Packing Method	Pack Quantity
2SA562	TO-92	Bulk	1000pcs/Bag
2SA562-TA	TO-92	Tape	2000pcs/Box

MAXIMUM RATINGS ($T_a=25^\circ\text{C}$ unless otherwise noted)

Symbol	Parameter	Value	Unit
V_{CBO}	Collector-Base Voltage	-35	V
V_{CEO}	Collector-Emitter Voltage	-30	V
V_{EBO}	Emitter-Base Voltage	-5	V
I_C	Collector Current -Continuous	-500	mA
P_C	Collector Power Dissipation	500	mW
T_J, T_{stg}	Operation Junction and Storage Temperature Range	-55~+150	$^\circ\text{C}$

ELECTRICAL CHARACTERISTICS

$T_a=25^\circ\text{C}$ unless otherwise specified

Parameter	Symbol	Test conditions	Min	Typ	Max	Unit
Collector-base breakdown voltage	$V(\text{BR})_{\text{CBO}}$	$I_{\text{C}}=-100\mu\text{A}, I_{\text{E}}=0$	-35			V
Collector-emitter breakdown voltage	$V(\text{BR})_{\text{CEO}}$	$I_{\text{C}}=-1\text{mA}, I_{\text{B}}=0\sim 30$				V
Emitter-base breakdown voltage	$V(\text{BR})_{\text{EBO}}$	$I_{\text{E}}=-100\mu\text{A}, I_{\text{C}}=0$	-5			V
Collector cut-off current	I_{CBO}	$V_{\text{CB}}=35\text{V}, I_{\text{E}}=0$			-0.1	μA
Emitter cut-off current	I_{EBO}	$V_{\text{EB}}=-5\text{V}, I_{\text{C}}=0$			-0.1	μA
DC current gain	h_{FE}	$V_{\text{CE}}=-1\text{V}, I_{\text{C}}=-100\text{mA}$	70		240	
Collector-emitter saturation voltage	$V_{\text{CE}(\text{SAT})}$	$I_{\text{C}}=-100\text{mA}, I_{\text{B}}=-10\text{mA}$			-0.25	V
Base-emitter voltage	V_{BE}	$V_{\text{CE}}=-1\text{V}, I_{\text{C}}=-100\text{mA}$			-1	V
Transition frequency	f_{T}	$V_{\text{CE}}=-6\text{V}, I_{\text{C}}=-20\text{mA}$		200		MHz
Collector output capacitance	C_{ob}	$V_{\text{CE}}=-6\text{V}, I_{\text{E}}=0, f=1\text{MHz}$	13			pF

CLASSIFICATION OF h_{FE}

RANK	O	Y
RANGE	70-140	120-240

Typical Characteristics

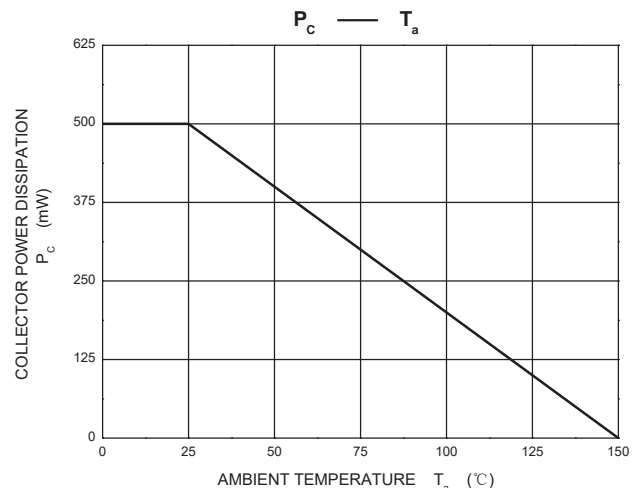
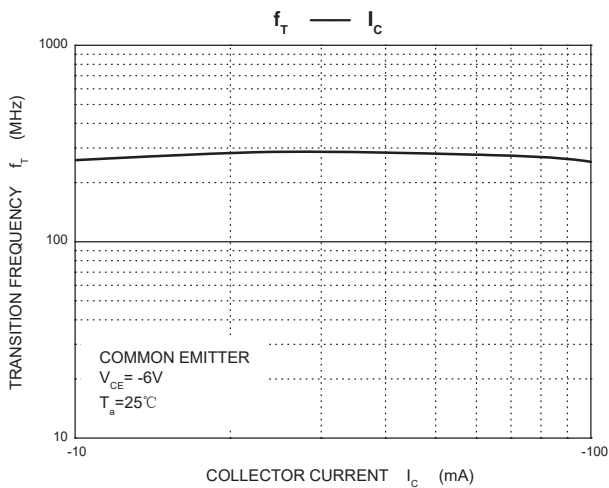
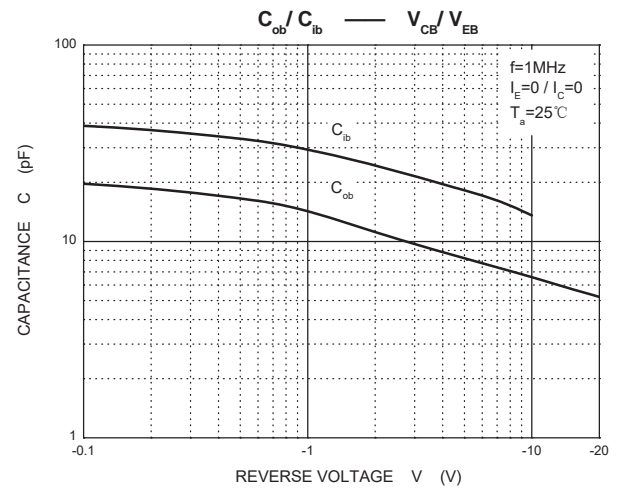
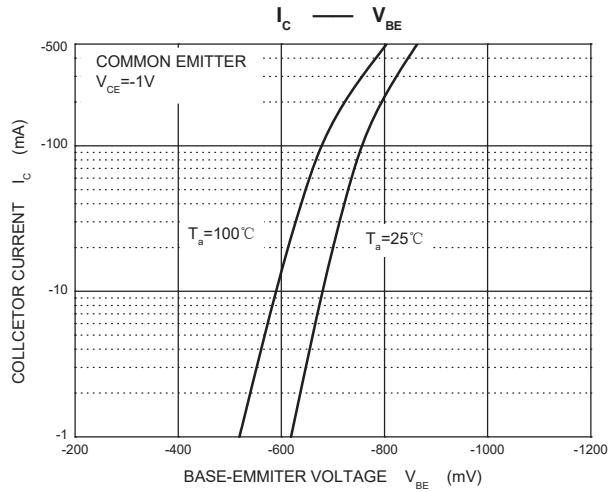
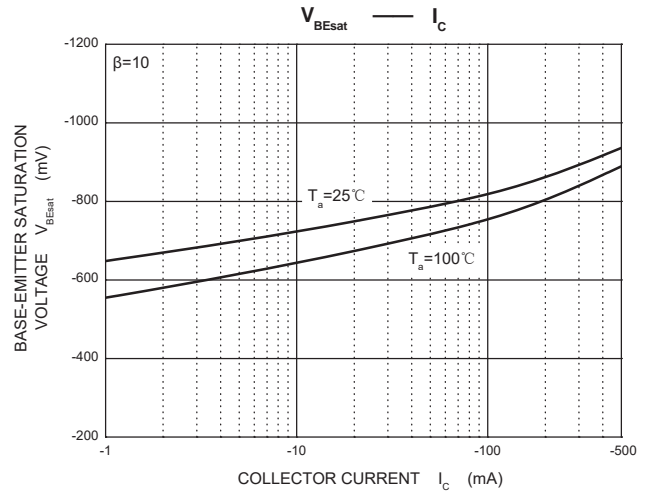
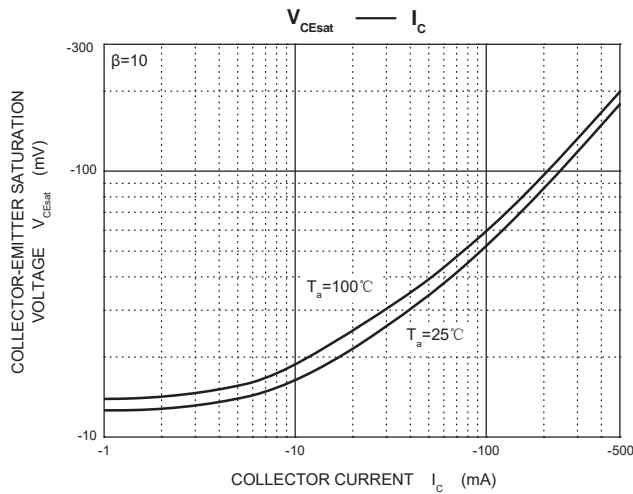
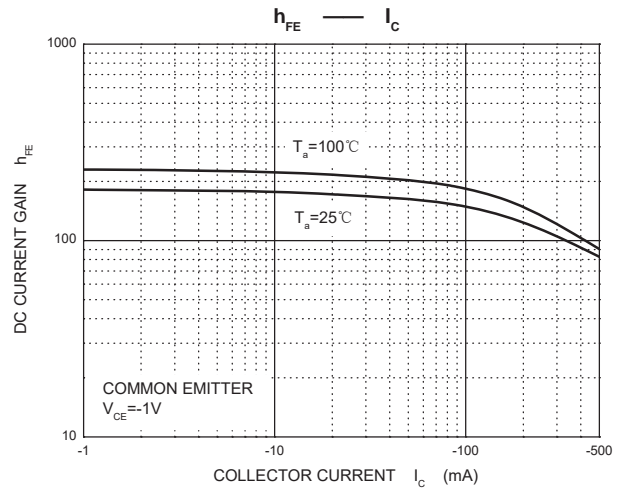
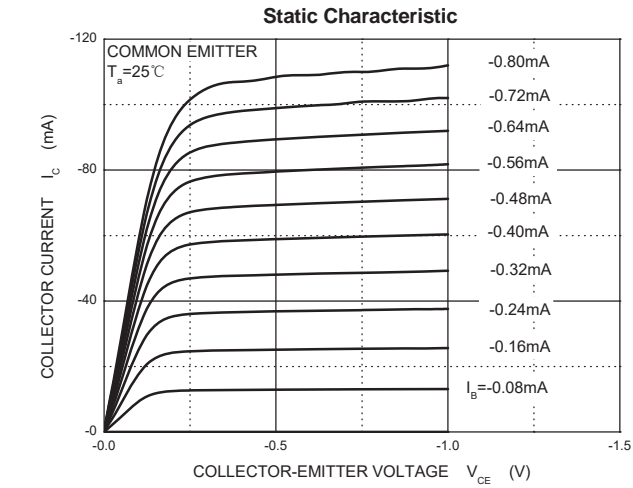

TO-92 Package Outline Dimensions

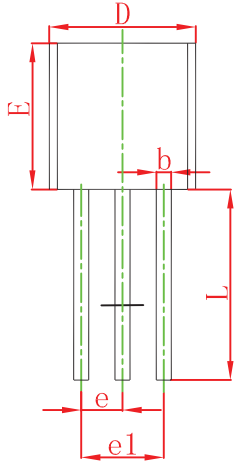
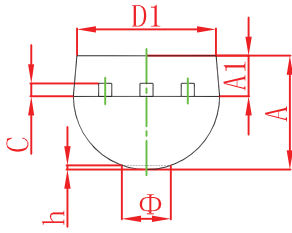

Symbol	Dimensions In Millimeters		Dimensions In Inches	
	Min	Max	Min	Max
A	3.300	3.700	0.130	0.146
A1	1.100	1.400	0.043	0.055
b	0.380	0.550	0.015	0.022
c	0.360	0.510	0.014	0.020
D	4.300	4.700	0.169	0.185
D1	3.430		0.135	
E	4.300	4.700	0.169	0.185
e	1.270 TYP		0.050 TYP	
e1	2.440	2.640	0.096	0.104
L	14.100	14.500	0.555	0.571
Φ		1.600		0.063
h	0.000	0.380	0.000	0.015

TO-92 Suggested Pad Layout

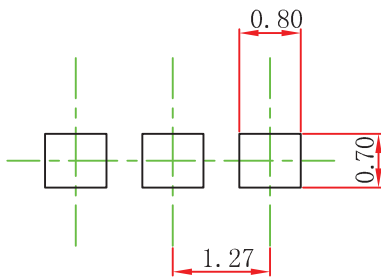

Note:

1. Controlling dimension: in millimeters.
2. General tolerance: $\pm 0.05\text{mm}$.
3. The pad layout is for reference purposes only.

TO-92 Tape and Reel

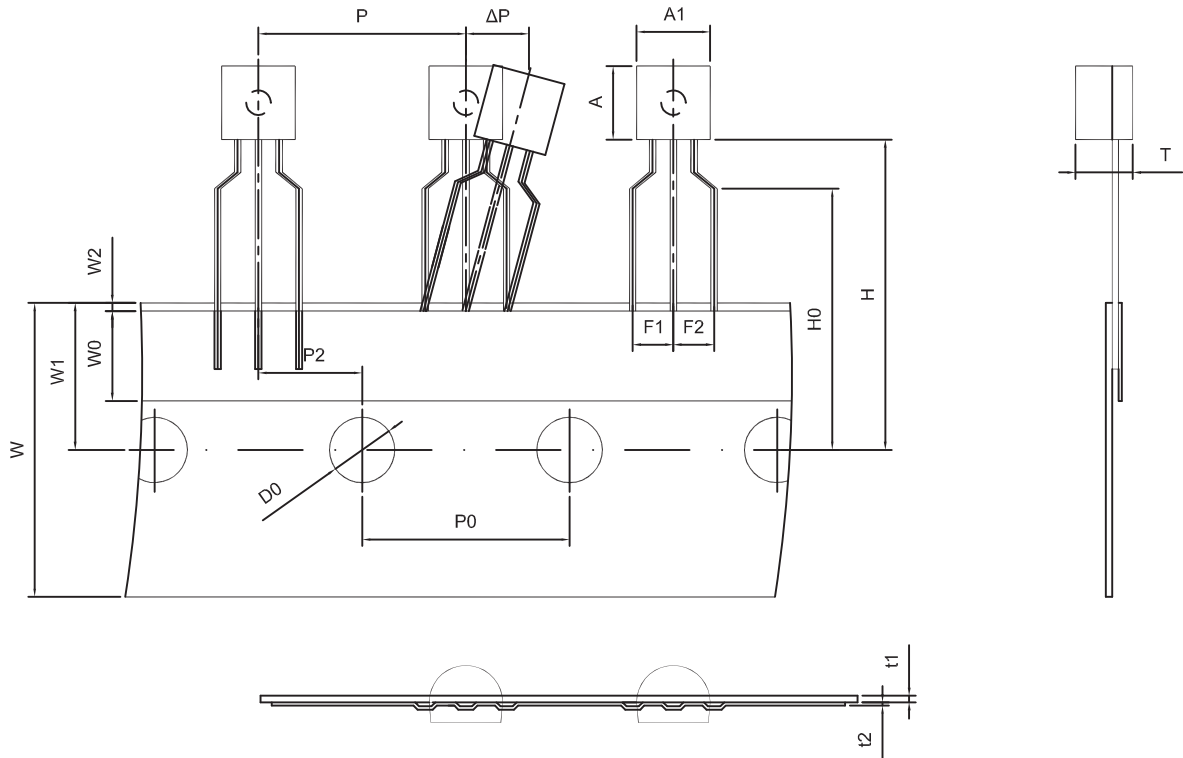

Dimiensions are in millimeter								
A1	A	T	P	P0	P2	F1	F2	W
4.5	4.5	3.5	12.7	12.7	6.35	2.5	2.5	18.0
W0	W1	W2	H	H0	D0	t1	t2	ΔP
6.0	9.0	1.0 MAX.	19.0	16.0	4.0	0.4	0.2	0

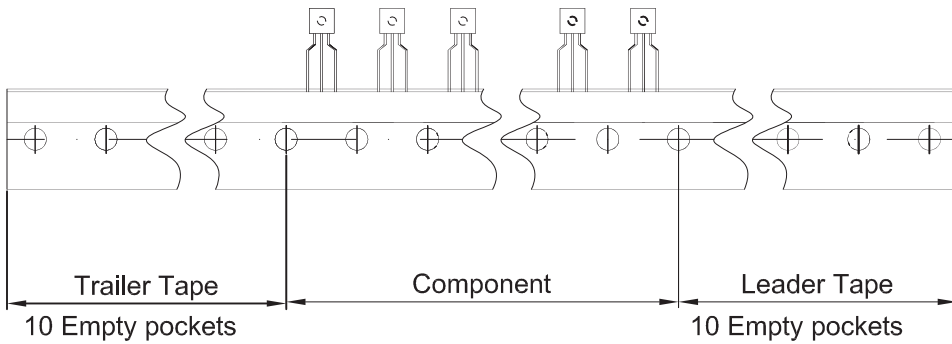

Package	Box	Box Size(mm)	Carton	Carton Size(mm)
TO-92	2000 pcs	333×162×43	20,000 pcs	350×340×250