



DONGGUAN NANJING ELECTRONICS LTD.,

TO-92 Plastic-Encapsulate Transistors

2SB1116 / 2SB1116A TRANSISTOR (PNP)

FEATURES

- High Collector Power Dissipation .
- Complementary to 2SD1616/2SD1616A

TO-92

1. EMITTER
2. COLLECTOR
3. BASE

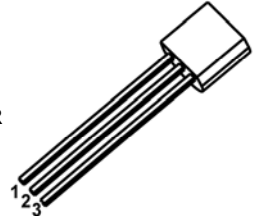

MARKING

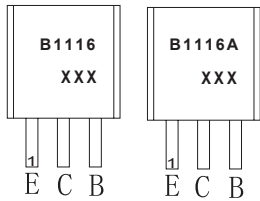

B1116,B1116A=Device code
XXX=Code

Equivalent Circuit

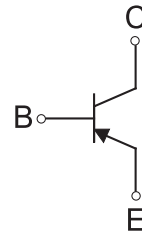

ORDERING INFORMATION

Part Number	Package	Packing Method	Pack Quantity
2SB1116	TO-92	Bulk	1000pcs/Bag
2SB1116-TA	TO-92	Tape	2000pcs/Box
2SB1116A	TO-92	Bulk	1000pcs/Bag
2SB1116A-TA	TO-92	Tape	2000pcs/Box

MAXIMUM RATINGS (T_a=25°C unless otherwise noted)

Symbol	Parameter	Value	Unit
V _{CBO}	Collector-Base Voltage	2SB1116	-60
		2SB1116A	-80
V _{CEO}	Collector-Emitter Voltage	2SB1116	-50
		2SB1116A	-60
V _{EBO}	Emitter-Base Voltage	-6	V
I _C	Collector Current -Continuous	-1	A
P _C	Collector Power Dissipation	0.75	W
T _J , T _{stg}	Operation Junction and Storage Temperature Range	-55-150	°C

ELECTRICAL CHARACTERISTICS

$T_a=25^\circ\text{C}$ unless otherwise specified

Parameter	Symbol	Test conditions	Min	Typ	Max	Unit
Collector-base breakdown voltage	$V_{(BR)CBO}$	$I_C=-100\mu\text{A}, I_E=0$	2SB1116 -60 2SB1116A -80			V
Collector-emitter breakdown voltage	$V_{(BR)CEO}$	$I_C=-1\text{mA}, I_B=0$	2SB1116 -50 2SB1116A -60			V
Emitter-base breakdown voltage	$V_{(BR)EBO}$	$I_E=-100\mu\text{A}, I_C=0$	-6			V
Collector cut-off current	I_{CBO}	$V_{CB}=-60\text{V}, I_E=0$	2SB1116		-0.1	μA
		$V_{CB}=-60\text{V}, I_E=0$	2SB1116A			
Emitter cut-off current	I_{EBO}	$V_{EB}=-6\text{V}, I_C=0$			-0.1	μA
DC current gain	$h_{FE(1)}$	$V_{CE}=-2\text{V}, I_C=-0.1\text{A}$	135		600	
	$h_{FE(2)}$	$V_{CE}=-2\text{V}, I_C=-1\text{A}$	81			
Collector-emitter saturation voltage	$V_{CE(sat)}$	$I_C=-1\text{A}, I_B=-50\text{mA}$			-0.3	V
Base-emitter saturation voltage	$V_{BE(sat)}$	$I_C=-1\text{A}, I_B=-50\text{mA}$			-1.2	V
Base-emitter voltage	V_{BE}	$V_{CE}=-2\text{V}, I_C=-0.05\text{A}$	-0.6		-0.7	V
Transition frequency	f_T	$V_{CE}=-2\text{V}, I_C=-0.1\text{A}$	70			MHz
Collector output capacitance	C_{ob}	$V_{CB}=-10\text{V}, I_E=0, f=1\text{MHz}$		25		pF
Turn-on time	t_{on}	$V_{CC}=-10\text{V}, I_C=-0.1\text{A}, I_{B1}=-I_{B2}=-0.01\text{A}, V_{BE(Off)}=2\text{to}3\text{V}$		0.07		μs
Storage time	t_s			0.7		μs
Fall time	t_f			0.07		μs

CLASSIFICATION OF $h_{FE(1)}$

Rank	L	K	U
Range	135-270	200-400	300-600

Typical Characteristics

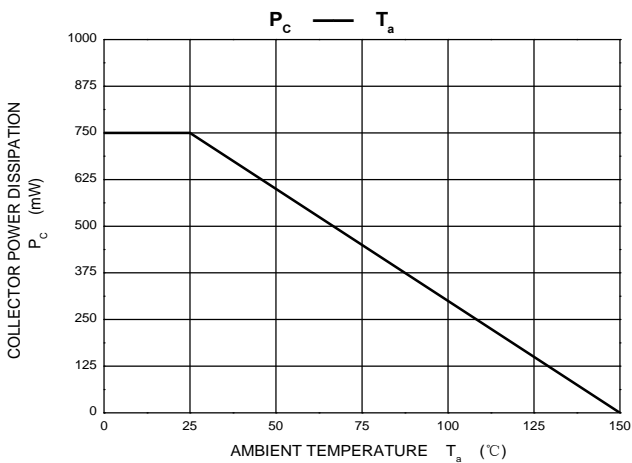
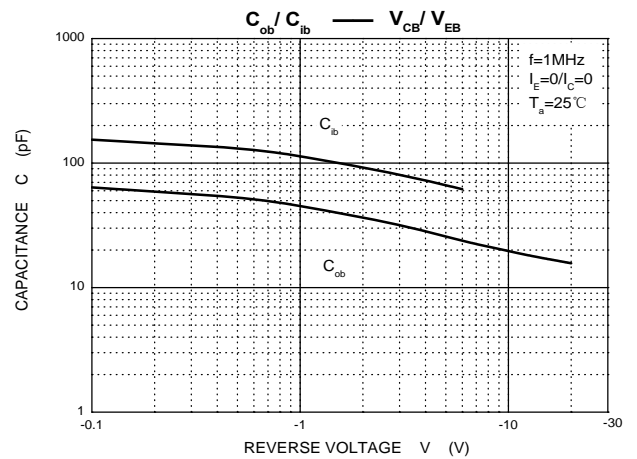
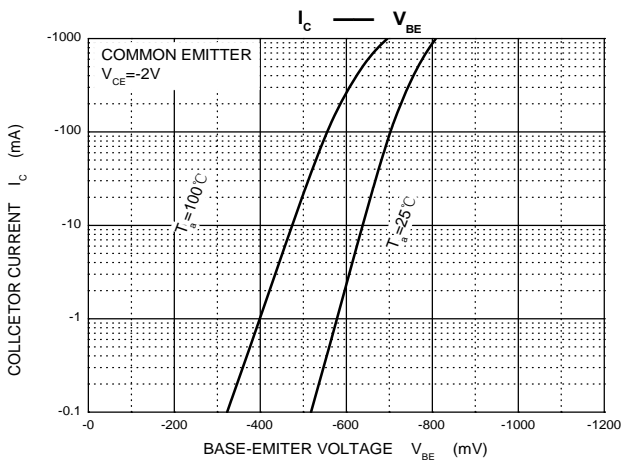
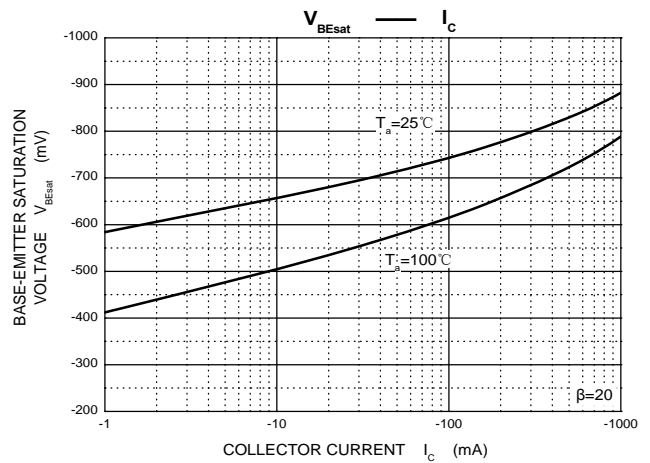
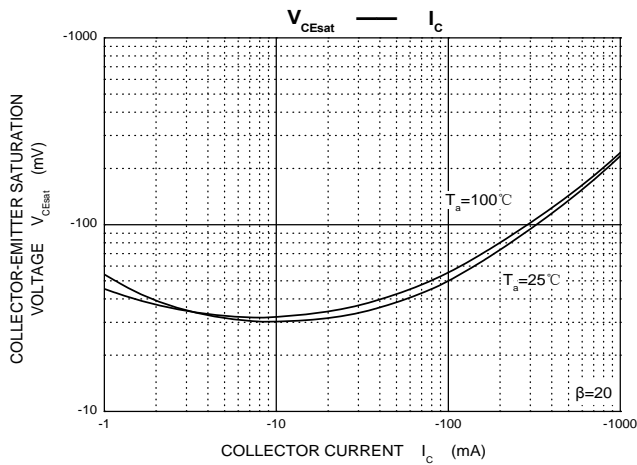
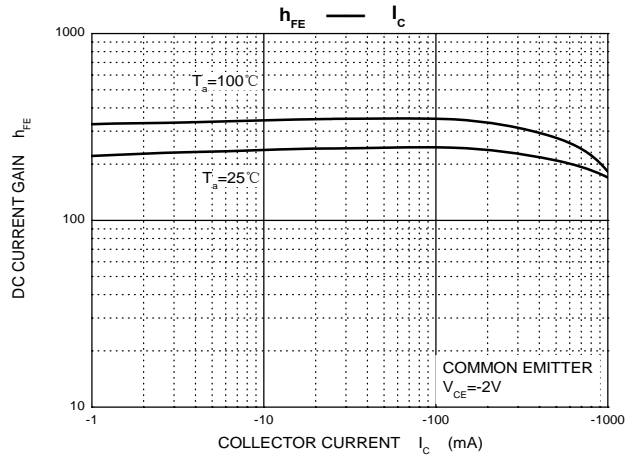
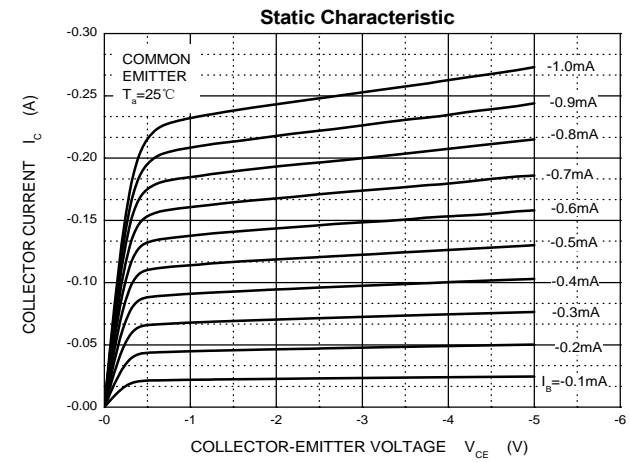

TO-92 Package Outline Dimensions

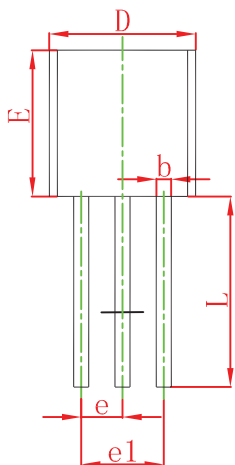
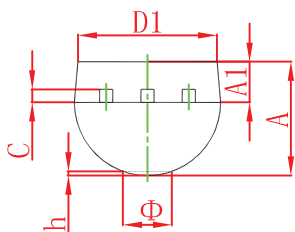

Symbol	Dimensions In Millimeters		Dimensions In Inches	
	Min	Max	Min	Max
A	3.300	3.700	0.130	0.146
A1	1.100	1.400	0.043	0.055
b	0.380	0.550	0.015	0.022
c	0.360	0.510	0.014	0.020
D	4.300	4.700	0.169	0.185
D1	3.430		0.135	
E	4.300	4.700	0.169	0.185
e	1.270 TYP		0.050 TYP	
e1	2.440	2.640	0.096	0.104
L	14.100	14.500	0.555	0.571
Φ		1.600		0.063
h	0.000	0.380	0.000	0.015

TO-92 Suggested Pad Layout

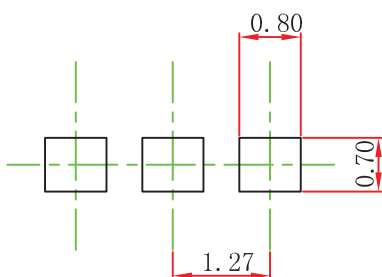

Note:

1. Controlling dimension: in millimeters.
2. General tolerance: $\pm 0.05\text{mm}$.
3. The pad layout is for reference purposes only.

TO-92 Tape and Reel

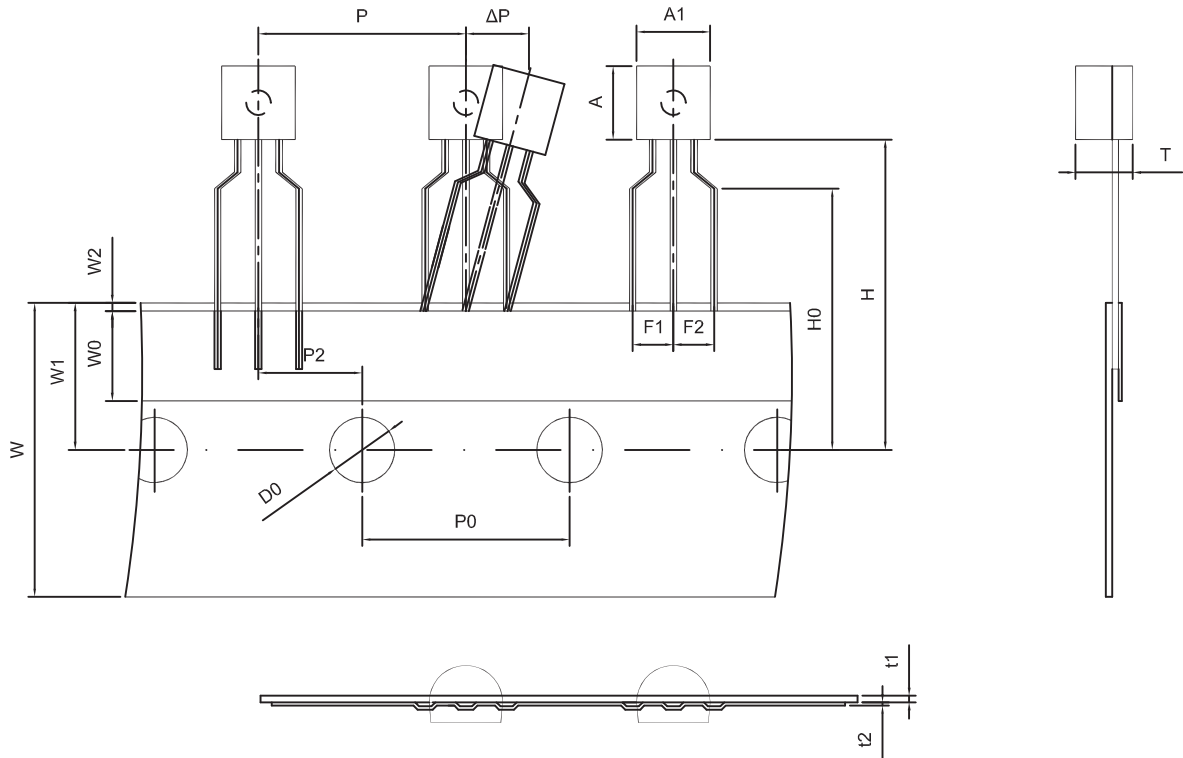

Dimiensions are in millimeter								
A1	A	T	P	P0	P2	F1	F2	W
4.5	4.5	3.5	12.7	12.7	6.35	2.5	2.5	18.0
W0	W1	W2	H	H0	D0	t1	t2	ΔP
6.0	9.0	1.0 MAX.	19.0	16.0	4.0	0.4	0.2	0

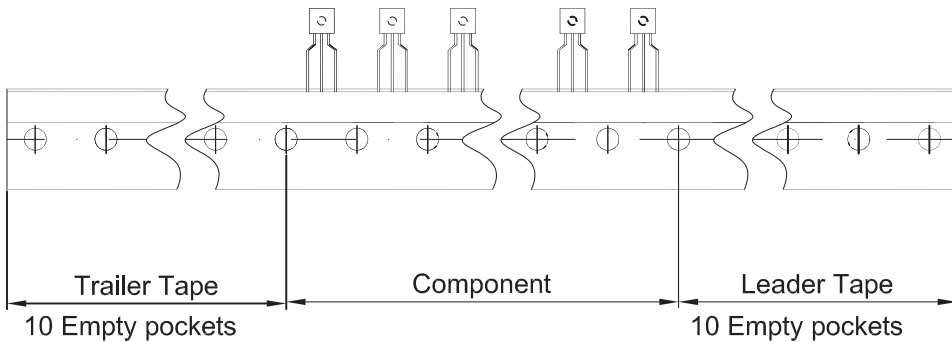

Package	Box	Box Size(mm)	Carton	Carton Size(mm)
TO-92	2000 pcs	333×162×43	20,000 pcs	350×340×250