



DONGGUAN NANJING ELECTRONICS LTD.,

## TO-92 Plastic-Encapsulate Transistors

**2SB1426** TRANSISTOR (PNP)

### FEATURES

- General Purpose Switching and Amplification

TO - 92

1. EMITTER

2. BASE

3. COLLECTOR

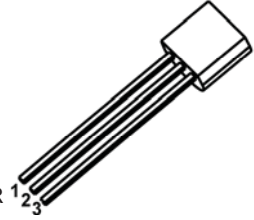

### MARKING

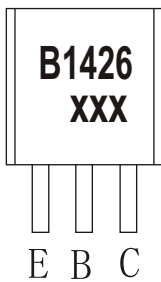

B1426=Device code

XXX=Code

### Equivalent Circuit

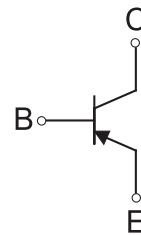

### ORDERING INFORMATION

Part Number	Package	Packing Method	Pack Quantity
2SB1426	TO-92	Bulk	1000pcs/Bag
2SB1426-TA	TO-92	Tape	2000pcs/Box

### MAXIMUM RATINGS (T<sub>a</sub>=25°C unless otherwise noted)

Symbol	Parameter	Value	Unit
V <sub>CB0</sub>	Collector-Base Voltage	-20	V
V <sub>CE0</sub>	Collector-Emitter Voltage	-20	V
V <sub>EB0</sub>	Emitter-Base Voltage	-6	V
I <sub>c</sub>	Collector Current -Continuous	-3	A
P <sub>D</sub>	Collector Power Dissipation	750	mW
R <sub>θJA</sub>	Thermal Resistance from Junction to Ambient	166	°C /W
T <sub>J</sub> , T <sub>stg</sub>	Operation Junction and Storage Temperature Range	-55~+150	°C

## ELECTRICAL CHARACTERISTICS

$T_a=25^\circ\text{C}$  unless otherwise specified

Parameter	Symbol	Test conditions	Min	Typ	Max	Unit
Collector-base breakdown voltage	$V_{(BR)CBO}$	$I_C=-0.05\text{mA}, I_E=0$	-20			V
Collector-emitter breakdown voltage	$V_{(BR)CEO}$	$I_C=-1\text{mA}, I_B=0$	-20			V
Emitter-base breakdown voltage	$V_{(BR)EBO}$	$I_E=-0.05\text{mA}, I_C=0$	-6			V
Collector cut-off current	$I_{CBO}$	$V_{CB}=-20\text{V}, I_E=0$			-0.1	$\mu\text{A}$
Emitter cut-off current	$I_{EBO}$	$V_{EB}=-5\text{V}, I_C=0$			-0.1	$\mu\text{A}$
DC current gain	$h_{FE}$	$V_{CE}=-2\text{V}, I_C=-0.1\text{A}$	82		390	
Collector-emitter saturation voltage	$V_{CE(sat)}$ *	$I_C=-2\text{A}, I_B=-0.1\text{A}$			-0.5	V
Collector output capacitance	$C_{ob}$	$V_{CB}=-10\text{V}, I_E=0, f=1\text{MHz}$		35		pF
Transition frequency	$f_T$	$V_{CE}=-2\text{V}, I_C=-0.5\text{A}, f=100\text{MHz}$		240		MHz

\*Pulse test

### CLASSIFICATION OF $h_{FE}$

RANK	P	Q	R
RANGE	82-180	120-270	180-390

## TO-92 Package Outline Dimensions

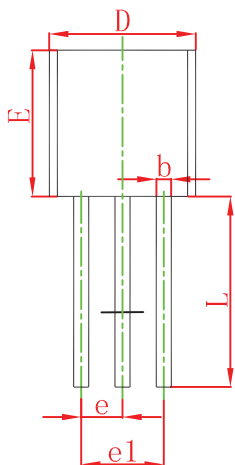
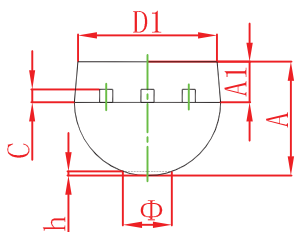

Symbol	Dimensions In Millimeters		Dimensions In Inches	
	Min	Max	Min	Max
A	3.300	3.700	0.130	0.146
A1	1.100	1.400	0.043	0.055
b	0.380	0.550	0.015	0.022
c	0.360	0.510	0.014	0.020
D	4.300	4.700	0.169	0.185
D1	3.430		0.135	
E	4.300	4.700	0.169	0.185
e	1.270 TYP		0.050 TYP	
e1	2.440	2.640	0.096	0.104
L	14.100	14.500	0.555	0.571
Φ		1.600		0.063
h	0.000	0.380	0.000	0.015

## TO-92 Suggested Pad Layout

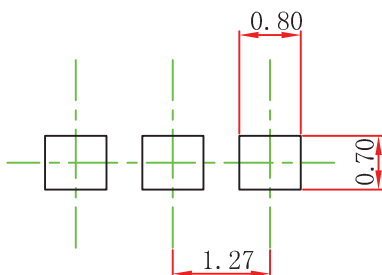

### Note:

1. Controlling dimension: in millimeters.
2. General tolerance:  $\pm 0.05\text{mm}$ .
3. The pad layout is for reference purposes only.

# TO-92 Tape and Reel

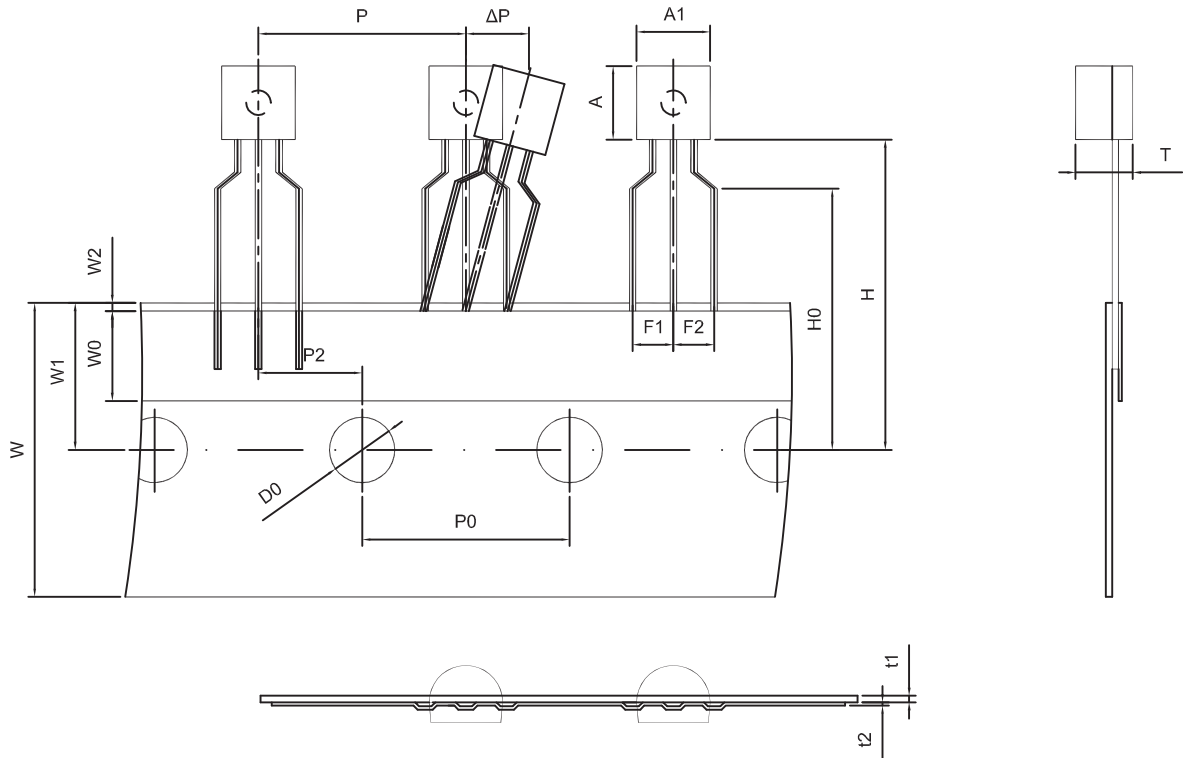

Dimensions are in millimeter								
A1	A	T	P	P0	P2	F1	F2	W
4.5	4.5	3.5	12.7	12.7	6.35	2.5	2.5	18.0
W0	W1	W2	H	H0	D0	t1	t2	$\Delta P$
6.0	9.0	1.0 MAX.	19.0	16.0	4.0	0.4	0.2	0

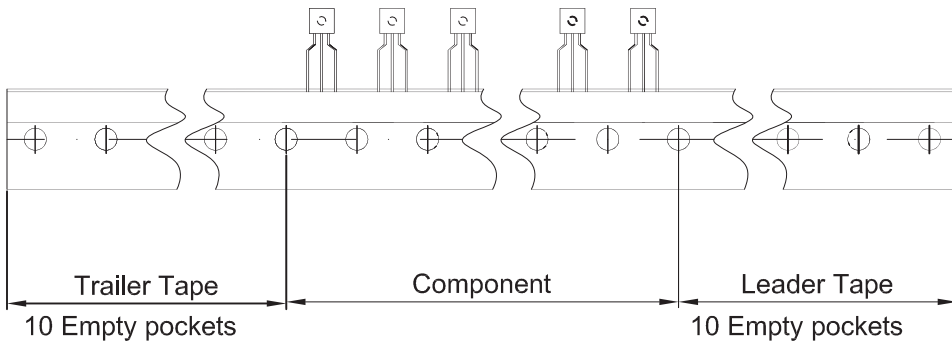

Package	Box	Box Size(mm)	Carton	Carton Size(mm)
TO-92	2000 pcs	333×162×43	20,000 pcs	350×340×250