



DONGGUAN NANJING ELECTRONICS LTD.,

## TO-92 Plastic-Encapsulate Transistors

### 2SC5345 TRANSISTOR (NPN)

#### FEATURES

- High Current Transition Frequency
- Low Output Capacitance
- Low Base Time Constant and High Gain
- Excellent Noise Response

#### APPLICATIONS

- RF Amplifier

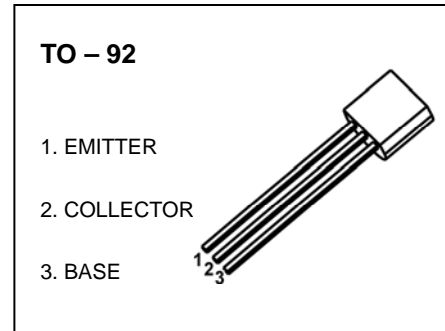

#### MARKING

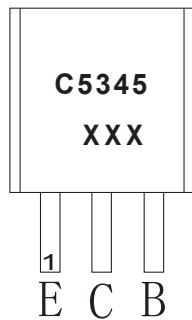

C5345=Device code  
XXX=Code

#### Equivalent Circuit

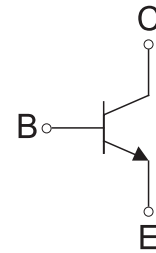

#### ORDERING INFORMATION

Part Number	Package	Packing Method	Pack Quantity
2SC5345	TO-92	Bulk	1000pcs/Bag
2SC5345-TA	TO-92	Tape	2000pcs/Box

#### MAXIMUM RATINGS ( $T_a=25^\circ\text{C}$ unless otherwise noted)

Symbol	Parameter	Value	Unit
$V_{CBO}$	Collector-Base Voltage	30	V
$V_{CEO}$	Collector-Emitter Voltage	20	V
$V_{EBO}$	Emitter-Base Voltage	4	V
$I_C$	Collector Current	20	mA
$P_C$	Collector Power Dissipation	625	mW
$R_{\theta JA}$	Thermal Resistance From Junction To Ambient	200	$^\circ\text{C}/\text{W}$
$T_J, T_{stg}$	Operation Junction and Storage Temperature Range	-55~+150	$^\circ\text{C}$

## ELECTRICAL CHARACTERISTICS

$T_a=25^{\circ}\text{C}$  unless otherwise specified

Parameter	Symbol	Test conditions	Min	Typ	Max	Unit
Collector-base breakdown voltage	$V_{(BR)CBO}$	$I_C=0.01\text{mA}, I_E=0$	30			V
Collector-emitter breakdown voltage	$V_{(BR)CEO}$	$I_C=5\text{mA}, I_B=0$	20			V
Emitter-base breakdown voltage	$V_{(BR)EBO}$	$I_E=0.01\text{mA}, I_C=0$	4			V
Collector cut-off current	$I_{CBO}$	$V_{CB}=30\text{V}, I_E=0$			0.5	$\mu\text{A}$
Emitter cut-off current	$I_{EBO}$	$V_{EB}=4\text{V}, I_C=0$			0.5	$\mu\text{A}$
DC current gain	$h_{FE(1)}$	$V_{CE}=6\text{V}, I_C=1\text{mA}$	40		240	
Collector-emitter saturation voltage	$V_{CE(sat)}$	$I_C=10\text{mA}, I_B=1\text{mA}$			0.3	V
Collector output capacitance	$C_{ob}$	$V_{CB}=6\text{V}, I_E=0, f=1\text{MHz}$		1.4		pF
Transition frequency	$f_T$	$V_{CE}=6\text{V}, I_C=1\text{mA}$		550		MHz

### CLASSIFICATION OF $h_{FE}$

RANK	R	O	Y
RANGE	40-80	70-140	120-240

# Typical Characteristics

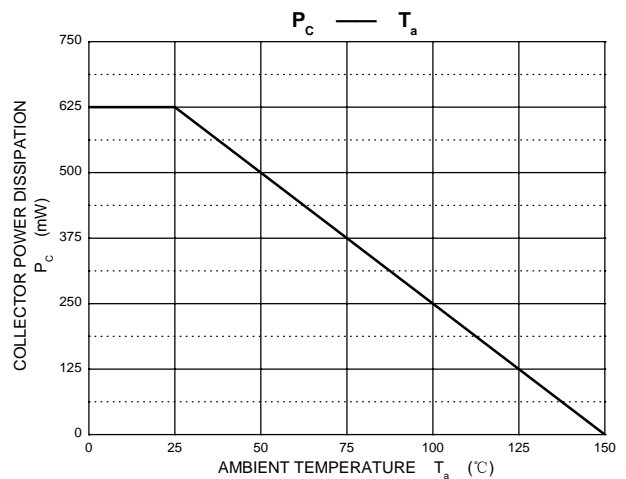
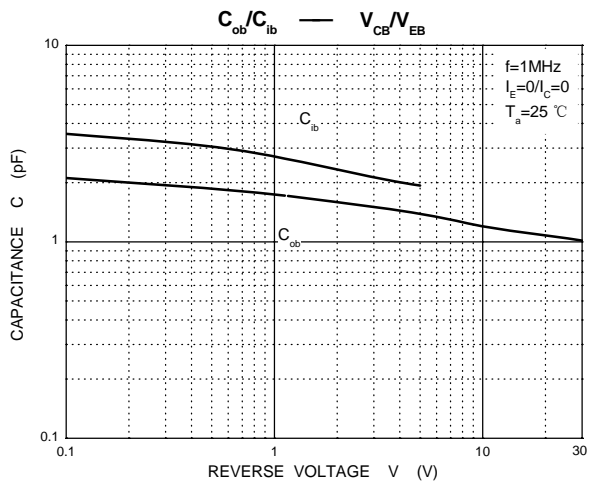
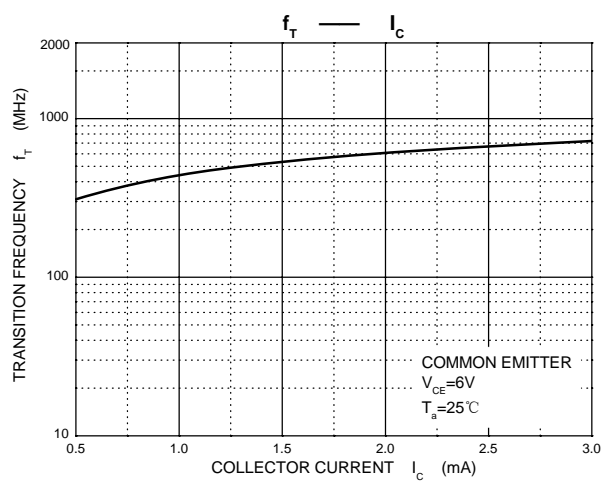
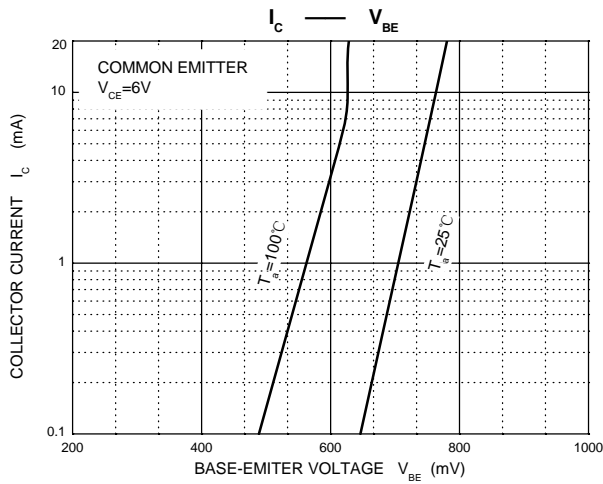
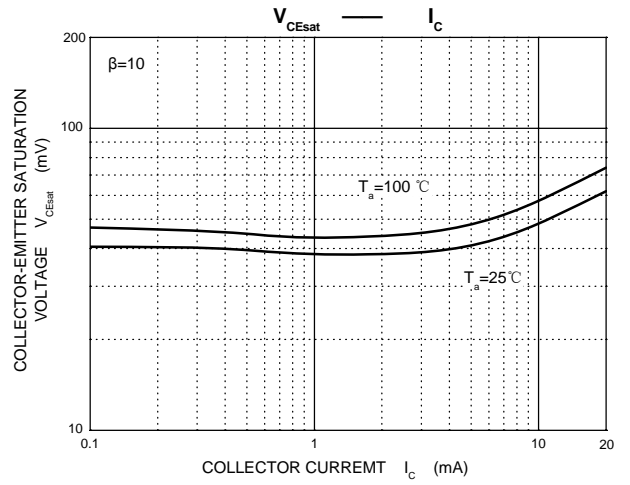
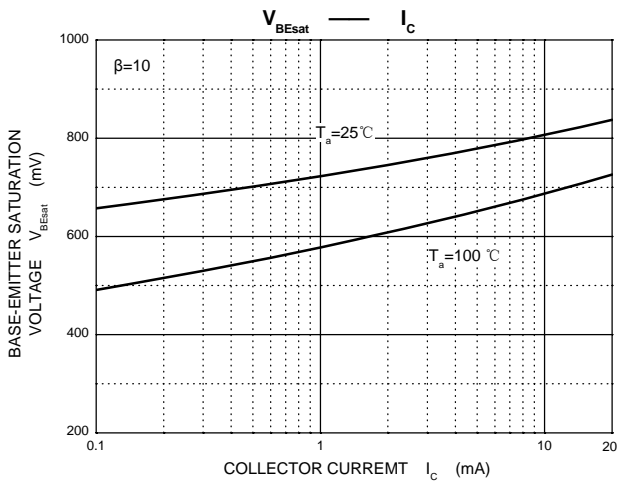
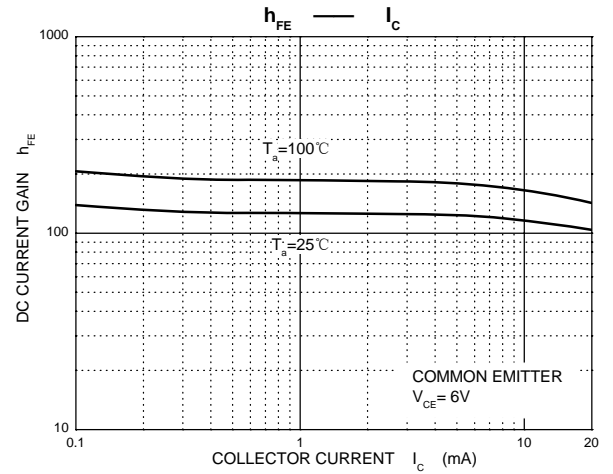
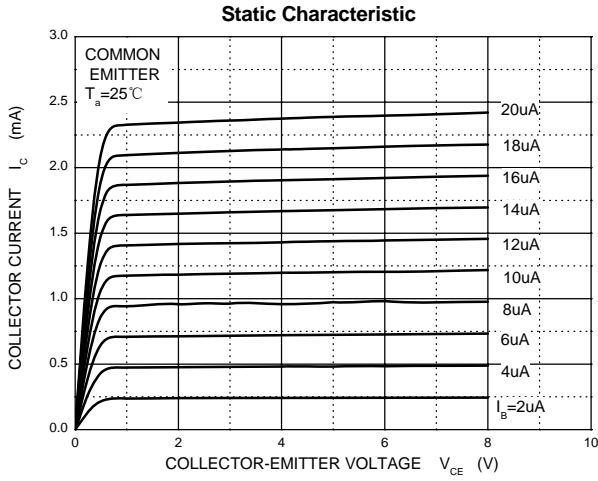

## TO-92 Package Outline Dimensions

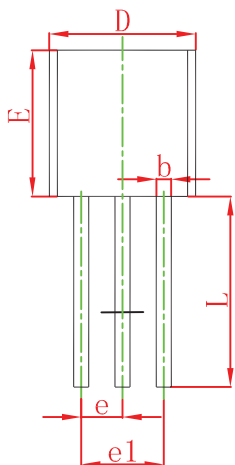
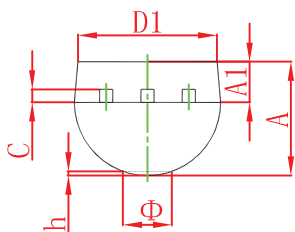

Symbol	Dimensions In Millimeters		Dimensions In Inches	
	Min	Max	Min	Max
A	3.300	3.700	0.130	0.146
A1	1.100	1.400	0.043	0.055
b	0.380	0.550	0.015	0.022
c	0.360	0.510	0.014	0.020
D	4.300	4.700	0.169	0.185
D1	3.430		0.135	
E	4.300	4.700	0.169	0.185
e	1.270 TYP		0.050 TYP	
e1	2.440	2.640	0.096	0.104
L	14.100	14.500	0.555	0.571
Φ		1.600		0.063
h	0.000	0.380	0.000	0.015

## TO-92 Suggested Pad Layout

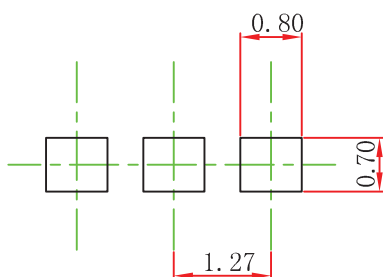

### Note:

1. Controlling dimension: in millimeters.
2. General tolerance:  $\pm 0.05\text{mm}$ .
3. The pad layout is for reference purposes only.

# TO-92 Tape and Reel

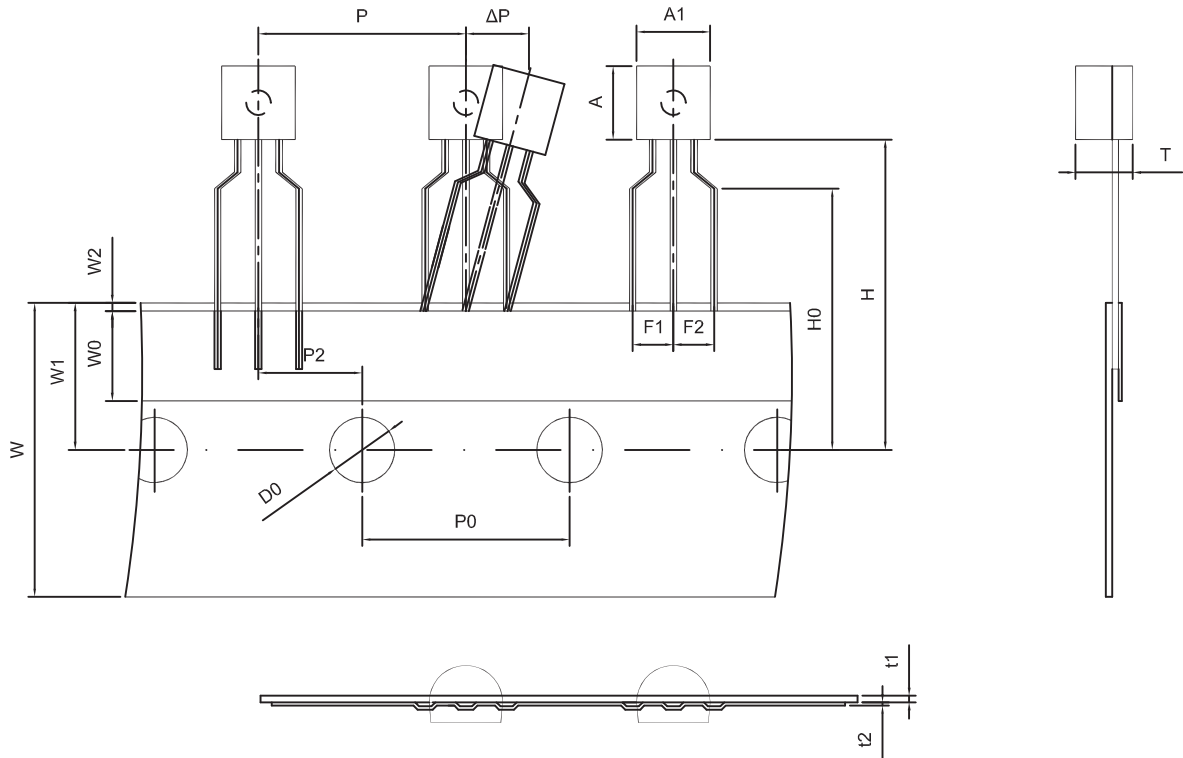

Dimensions are in millimeter								
A1	A	T	P	P0	P2	F1	F2	W
4.5	4.5	3.5	12.7	12.7	6.35	2.5	2.5	18.0
W0	W1	W2	H	H0	D0	t1	t2	$\Delta P$
6.0	9.0	1.0 MAX.	19.0	16.0	4.0	0.4	0.2	0

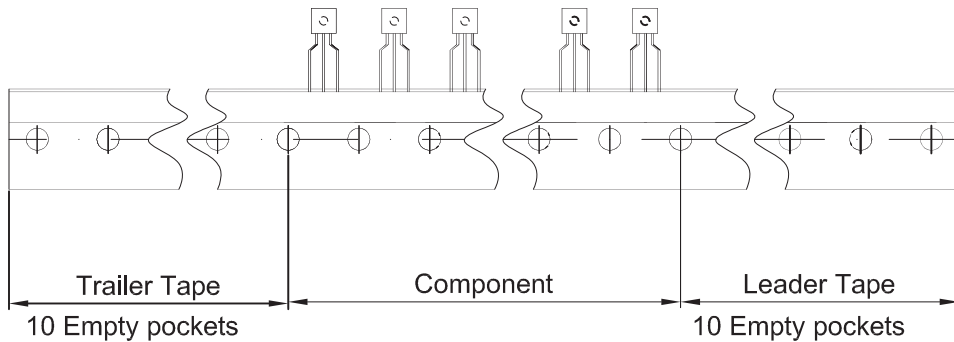

Package	Box	Box Size(mm)	Carton	Carton Size(mm)
TO-92	2000 pcs	333×162×43	20,000 pcs	350×340×250