



DONGGUAN NANJING ELECTRONICS LTD.,

TO-92 Plastic-Encapsulate Transistors

3DD13001 TRANSISTOR (NPN)

FEATURES

- Power switching applications

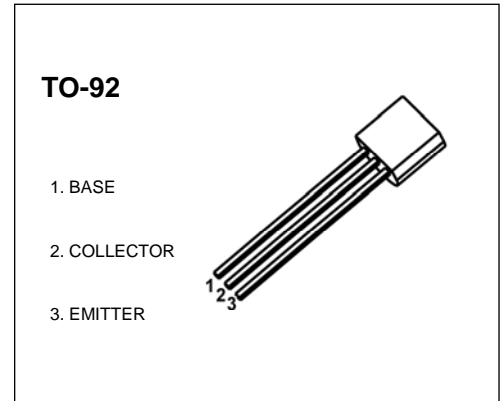

MARKING

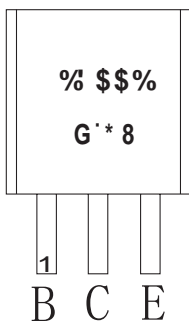

13001=Device code

S 6D=Code

Equivalent Circuit

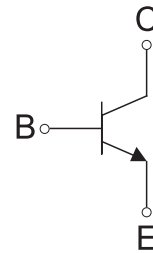

ORDERING INFORMATION

Part Number	Package	Packing Method	Pack Quantity
3DD13001	TO-92	Bulk	1000pcs/Bag
3DD13001-TA	TO-92	Tape	2000pcs/Box

MAXIMUM RATINGS ($T_a=25^{\circ}\text{C}$ unless otherwise noted)

Symbol	Parameter	Value	Unit
V_{CBO}	Collector-Base Voltage	700	V
V_{CEO}	Collector-Emitter Voltage	400	V
V_{EBO}	Emitter-Base Voltage	8	V
I_C	Collector Current -Continuous	0.2	A
P_C	Collector Power Dissipation	0.625	W
T_J, T_{stg}	Operation Junction and Storage Temperature Range	-55 ~150	$^{\circ}\text{C}$

ELECTRICAL CHARACTERISTICS

$T_a=25^\circ\text{C}$ unless otherwise specified

Parameter	Symbol	Test conditions	Min	Typ	Max	Unit
Collector-base breakdown voltage	$V_{(BR)CBO}$	$I_C=1\text{mA}, I_E=0$	700			V
Collector-emitter breakdown voltage	$V_{(BR)CEO}$	$I_C=1\text{mA}, I_B=0$	400		450	V
Emitter-base breakdown voltage	$V_{(BR)EBO}$	$I_E=0.1\text{mA}, I_C=0$	8			V
Collector cut-off current	I_{CBO}	$V_{CB}=600\text{V}, I_E=0$			100	μA
Collector cut-off current	I_{CEO}	$V_{CE}=400\text{V}, I_B=0$			100	μA
Emitter cut-off current	I_{EBO}	$V_{EB}=7\text{V}, I_C=0$			100	μA
DC current gain	$h_{FE(1)}$	$V_{CE}=20\text{V}, I_C=20\text{mA}$	14		29	
	$h_{FE(2)}$	$V_{CE}=10\text{V}, I_C=0.25\text{mA}$	5			
	$h_{FE(3)}$	$V_{CE}=5\text{V}, I_C=0.5\text{A}$	1			
Collector-emitter saturation voltage	$V_{CE(sat)}$	$I_C=50\text{mA}, I_B=10\text{mA}$			0.4	V
Base-emitter saturation voltage	$V_{BE(sat)}$	$I_C=50\text{mA}, I_B=10\text{mA}$			1.1	V
Transition frequency	f_T	$V_{CE}=20\text{V}, I_C=20\text{mA}, f=1\text{MHz}$	8			MHz
Rail time	t_r	$I_C=0.1\text{A}$			0.9	μs
Storage time	t_s		0.9		2.4	μs

CLASSIFICATION OF $h_{FE(1)}$

Range	14-17	17-20	20-23	23-26	26-29
-------	-------	-------	-------	-------	-------

CLASSIFICATION OF t_s

Range	0.9-2 (μs)	1.4-2.4 (μs)
-------	-------------------------	---------------------------

Typical Characteristics

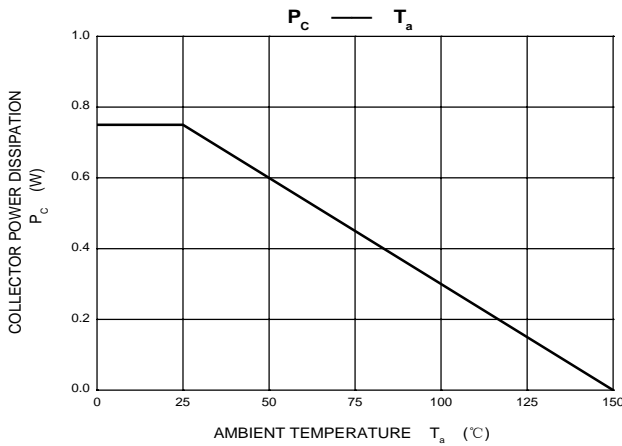
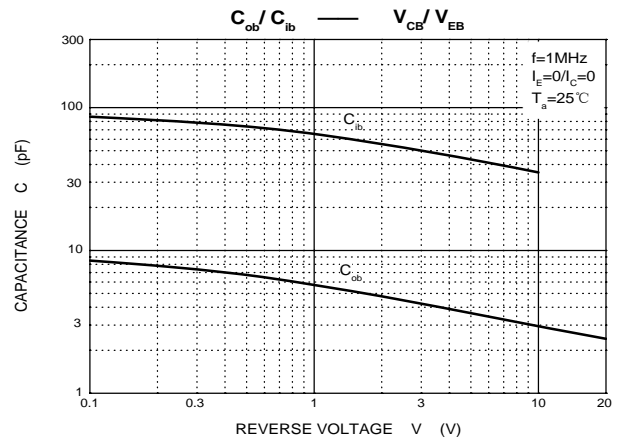
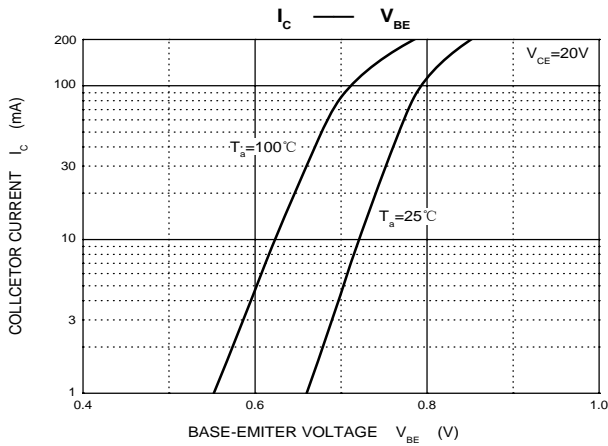
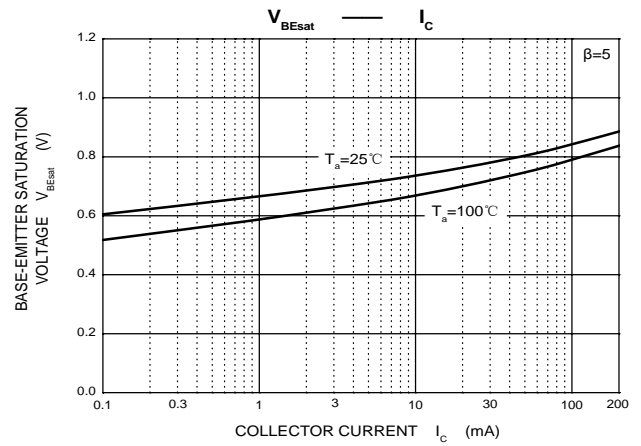
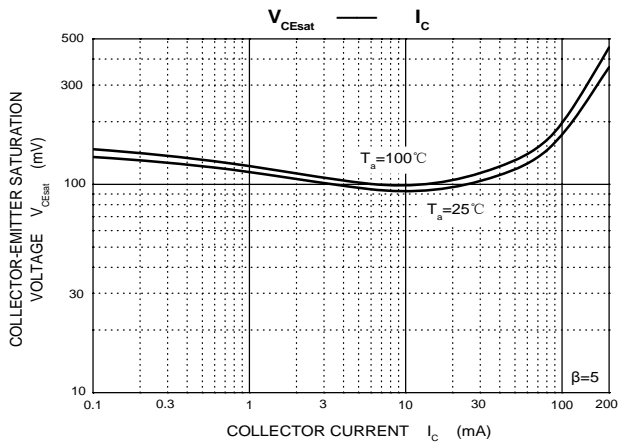
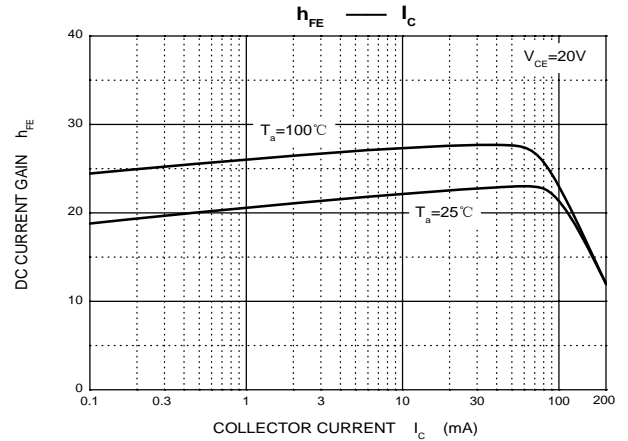
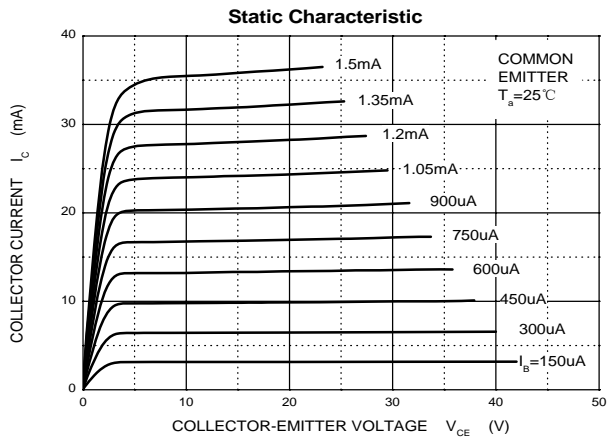

TO-92 Package Outline Dimensions

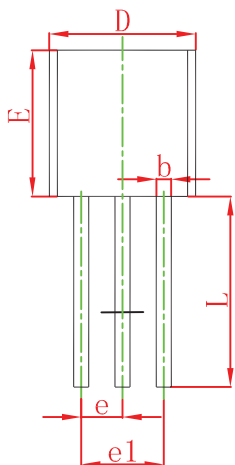
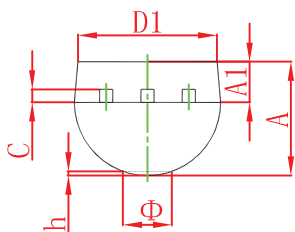

Symbol	Dimensions In Millimeters		Dimensions In Inches	
	Min	Max	Min	Max
A	3.300	3.700	0.130	0.146
A1	1.100	1.400	0.043	0.055
b	0.380	0.550	0.015	0.022
c	0.360	0.510	0.014	0.020
D	4.300	4.700	0.169	0.185
D1	3.430		0.135	
E	4.300	4.700	0.169	0.185
e	1.270 TYP		0.050 TYP	
e1	2.440	2.640	0.096	0.104
L	14.100	14.500	0.555	0.571
Φ		1.600		0.063
h	0.000	0.380	0.000	0.015

TO-92 Suggested Pad Layout

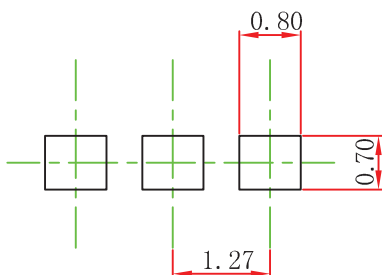

Note:

1. Controlling dimension: in millimeters.
2. General tolerance: $\pm 0.05\text{mm}$.
3. The pad layout is for reference purposes only.

TO-92 Tape and Reel

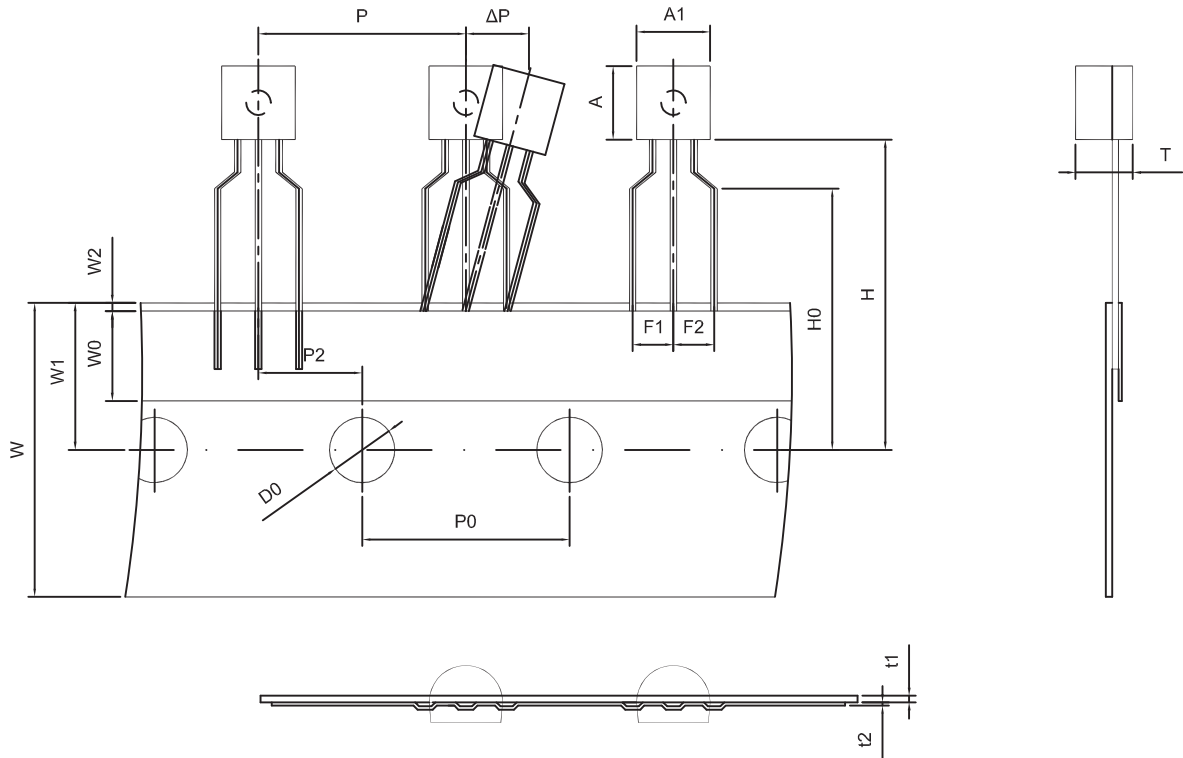

Dimiensions are in millimeter								
A1	A	T	P	P0	P2	F1	F2	W
4.5	4.5	3.5	12.7	12.7	6.35	2.5	2.5	18.0
W0	W1	W2	H	H0	D0	t1	t2	ΔP
6.0	9.0	1.0 MAX.	19.0	16.0	4.0	0.4	0.2	0

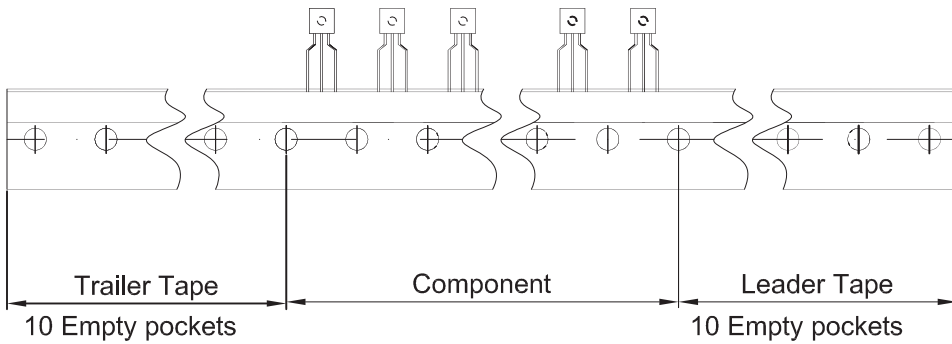

Package	Box	Box Size(mm)	Carton	Carton Size(mm)
TO-92	2000 pcs	333×162×43	20,000 pcs	350×340×250