



DONGGUAN NANJING ELECTRONICS LTD.,

## TO-92 Plastic-Encapsulate Transistors

### A94 TRANSISTOR (PNP)

#### FEATURES

- High Breakdown Voltage

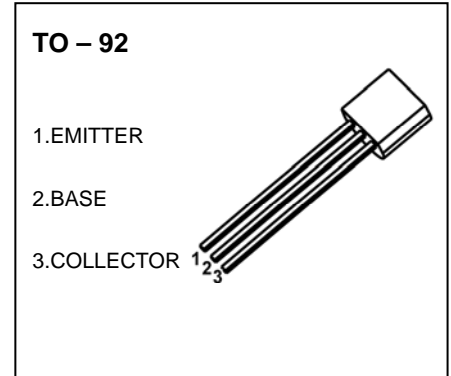

#### MARKING

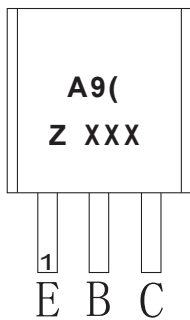

A94=Device code  
Z=Rank of  $h_{FE}$   
XXX=Code

#### Equivalent Circuit

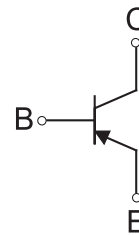

#### ORDERING INFORMATION

Part Number	Package	Packing Method	Pack Quantity
A94	TO-92	Bulk	1000pcs/Bag
A94-TA	TO-92	Tape	2000pcs/Box

#### MAXIMUM RATINGS ( $T_a=25^\circ\text{C}$ unless otherwise noted)

Symbol	Parameter	Value	Unit
$V_{CB0}$	Collector-Base Voltage	-400	V
$V_{CE0}$	Collector-Emitter Voltage	-400	V
$V_{EB0}$	Emitter-Base Voltage	-5	V
$I_C$	Collector Current -Continuous	-0.2	A
$I_{CA}$	Collector Current -Pulsed	-0.3	A
$P_C$	Collector Power Dissipation	625	mW
$R_{\theta JA}$	Thermal Resistance From Junction To ambient	200	$^\circ\text{C}/\text{W}$
$T_J, T_{stg}$	Operation Junction and Storage Temperature Range	-55~+150	$^\circ\text{C}$

## ELECTRICAL CHARACTERISTICS

$T_a=25^\circ\text{C}$  unless otherwise specified

Parameter	Symbol	Test conditions	Min	Typ	Max	Unit
Collector-base breakdown voltage	$V_{(BR)CBO}$	$I_C=-100\mu\text{A}, I_E=0$	-400			V
Collector-emitter breakdown voltage	$V_{(BR)CEO}$	$I_C=-1\text{mA}, I_B=0$	-400			V
Emitter-base breakdown voltage	$V_{(BR)EBO}$	$I_E=-100\mu\text{A}, I_C=0$	-5			V
Collector cut-off current	$I_{CBO}$	$V_{CB}=-400\text{V}, I_E=0$			-0.1	$\mu\text{A}$
Collector cut-off current	$I_{CEO}$	$V_{CE}=-400\text{V}, I_B=0$			-5	$\mu\text{A}$
Emitter cut-off current	$I_{EBO}$	$V_{EB}=-4\text{V}, I_C=0$			-0.1	$\mu\text{A}$
DC current gain	$h_{FE(1)}$	$V_{CE}=-10\text{V}, I_C=-10\text{mA}$	80		300	
	$h_{FE(2)}$	$V_{CE}=-10\text{V}, I_C=-1\text{mA}$	70			
	$h_{FE(3)}$	$V_{CE}=-10\text{V}, I_C=-100\text{mA}$	60			
	$h_{FE(4)}$	$V_{CE}=-10\text{V}, I_C=-50\text{mA}$	80			
Collector-emitter saturation voltage	$V_{CE(sat)(1)}$	$I_C=-10\text{mA}, I_B=-1\text{mA}$			-0.2	V
	$V_{CE(sat)(2)}$	$I_C=-50\text{mA}, I_B=-5\text{mA}$			-0.3	V
Base-emitter saturation voltage	$V_{BE(sat)}$	$I_C=-10\text{mA}, I_B=-1\text{mA}$			-0.75	V
Transition frequency	$f_T$	$V_{CE}=-20\text{V}, I_C=-10\text{mA}, f=30\text{MHz}$	50			MHz

### CLASSIFICATION OF $h_{FE(1)}$

RANK	A	B	C
RANGE	80-100	100-200	200-300

# Typical Characteristics

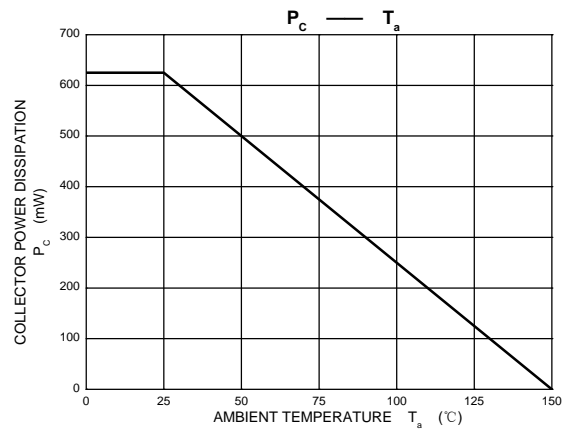
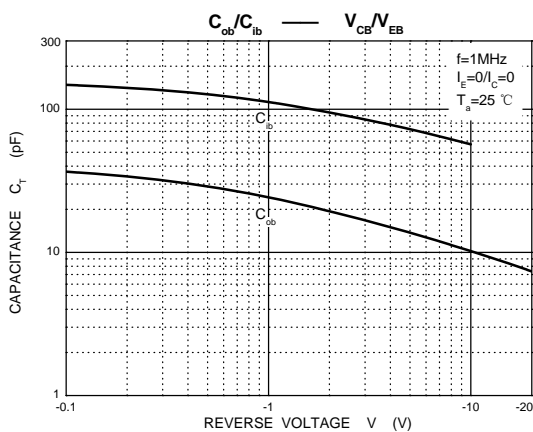
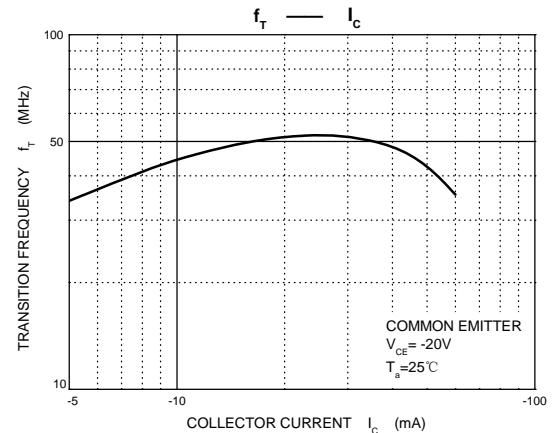
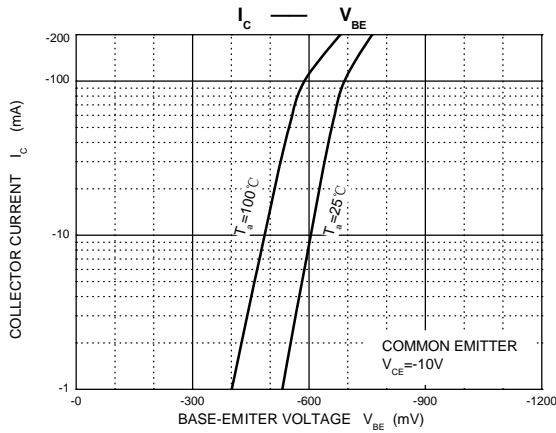
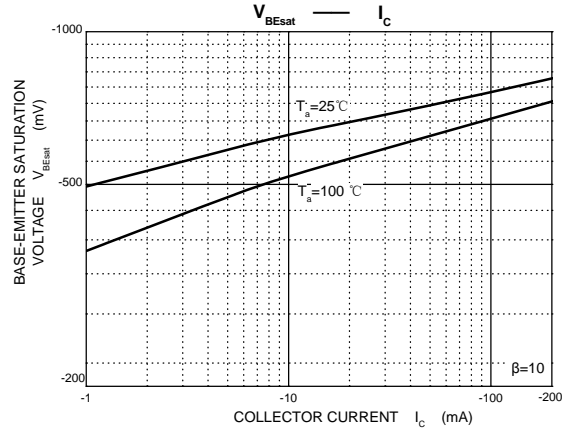
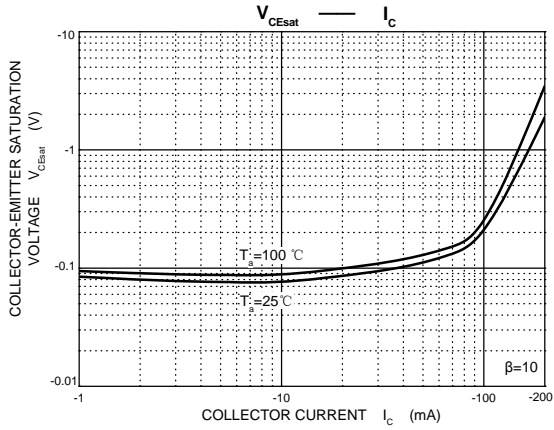
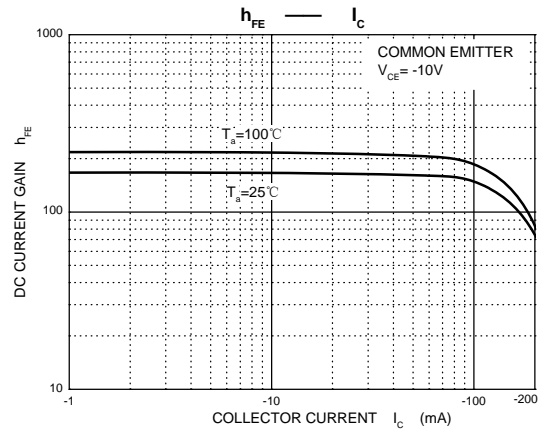
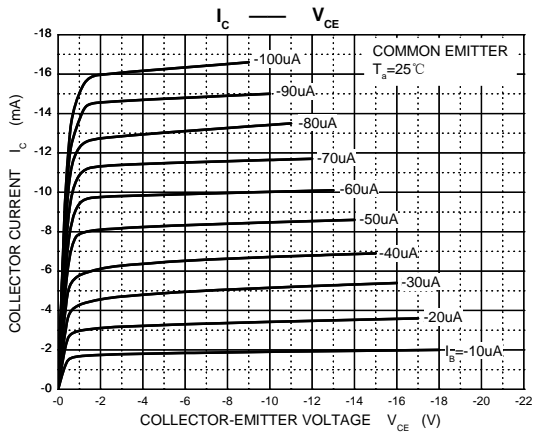

## TO-92 Package Outline Dimensions

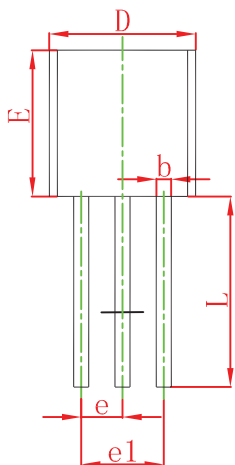
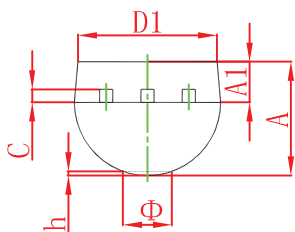

Symbol	Dimensions In Millimeters		Dimensions In Inches	
	Min	Max	Min	Max
A	3.300	3.700	0.130	0.146
A1	1.100	1.400	0.043	0.055
b	0.380	0.550	0.015	0.022
c	0.360	0.510	0.014	0.020
D	4.300	4.700	0.169	0.185
D1	3.430		0.135	
E	4.300	4.700	0.169	0.185
e	1.270 TYP		0.050 TYP	
e1	2.440	2.640	0.096	0.104
L	14.100	14.500	0.555	0.571
Φ		1.600		0.063
h	0.000	0.380	0.000	0.015

## TO-92 Suggested Pad Layout

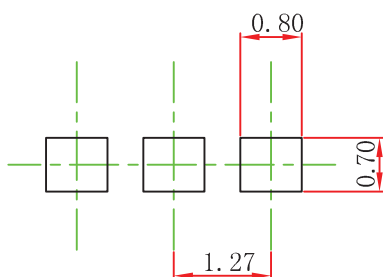

### Note:

1. Controlling dimension: in millimeters.
2. General tolerance:  $\pm 0.05\text{mm}$ .
3. The pad layout is for reference purposes only.

# TO-92 Tape and Reel

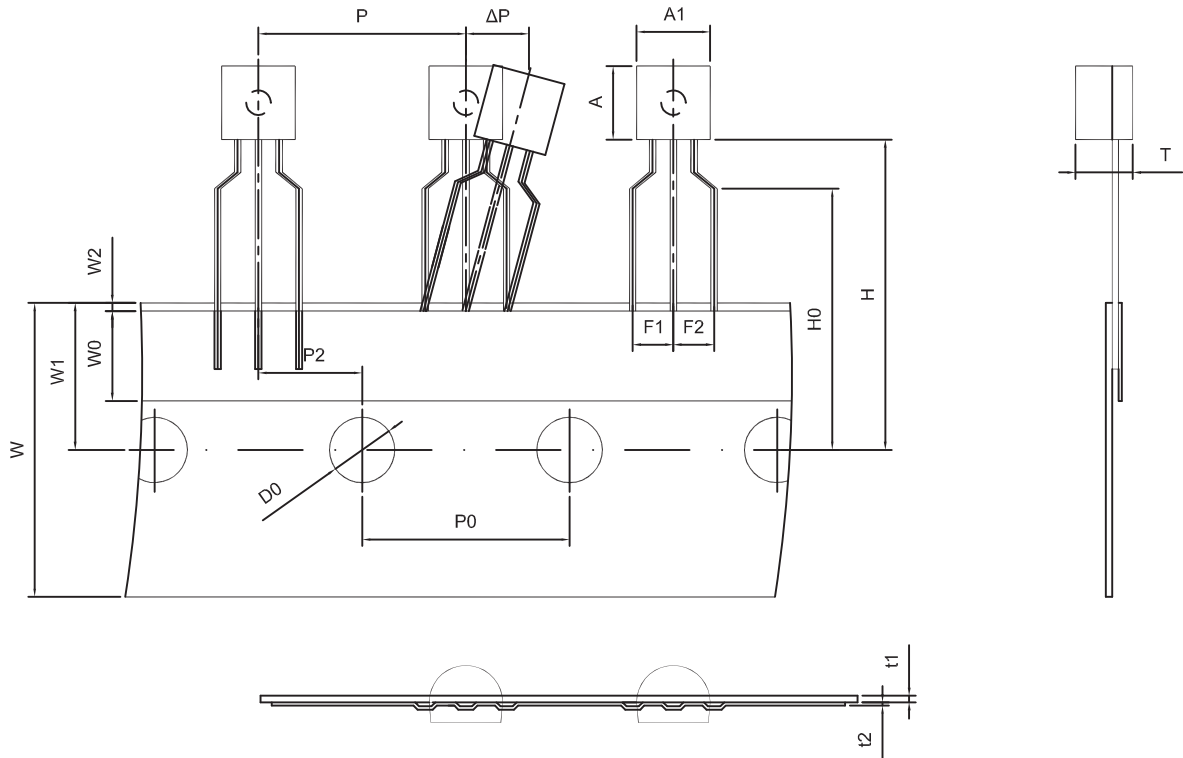

Dimiensions are in millimeter								
A1	A	T	P	P0	P2	F1	F2	W
4.5	4.5	3.5	12.7	12.7	6.35	2.5	2.5	18.0
W0	W1	W2	H	H0	D0	t1	t2	$\Delta P$
6.0	9.0	1.0 MAX.	19.0	16.0	4.0	0.4	0.2	0

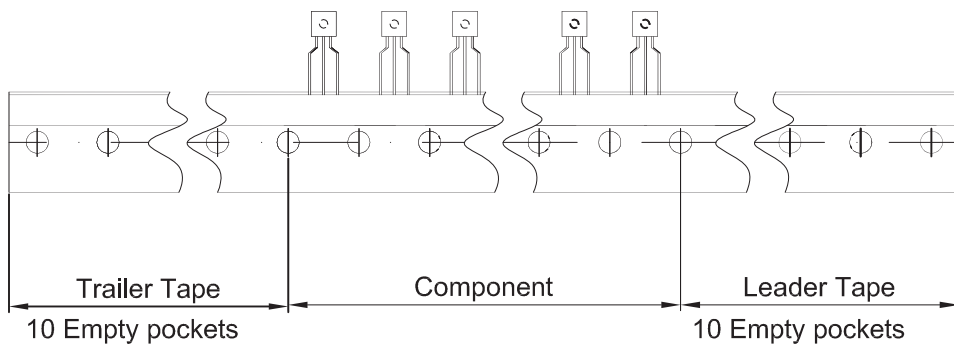

Package	Box	Box Size(mm)	Carton	Carton Size(mm)
TO-92	2000 pcs	333×162×43	20,000 pcs	350×340×250