



DONGGUAN NANJING ELECTRONICS LTD.,

TO-92 Plastic-Encapsulate Transistors

MPS651 TRANSISTOR (NPN)

FEATURES

- General Purpose Amplifier

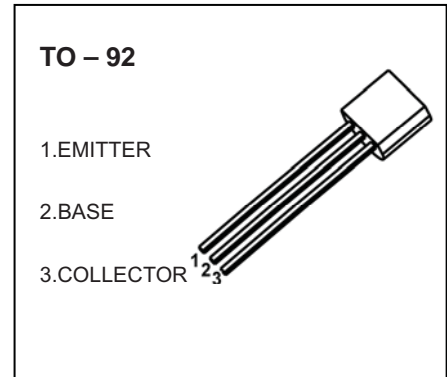

MARKING

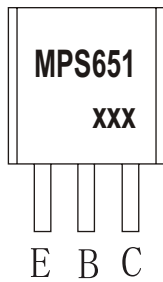

MPS651=Device code
XXX=Code

Equivalent Circuit

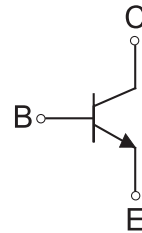

ORDERING INFORMATION

Part Number	Package	Packing Method	Pack Quantity
MPS651	TO-92	Bulk	1000pcs/Bag
MPS651-TA	TO-92	Tape	2000pcs/Box

MAXIMUM RATINGS (T_a=25°C unless otherwise noted)

Symbol	Parameter	Value	Unit
V _{CB0}	Collector-Base Voltage	80	V
V _{CEO}	Collector-Emitter Voltage	60	V
V _{EBO}	Emitter-Base Voltage	5	V
I _c	Collector Current -Continuous	2	A
P _D	Collector Power Dissipation	625	mW
R _{θJA}	Thermal Resistance rom Junction to Ambient	200	°C /W
T _J ,T _{stg}	Operation Junction and Storage Temperature Range	-55~+150	°C

ELECTRICAL CHARACTERISTICS

T =25 °C unless otherwise specified

Parameter	Symbol	Test conditions	Min	Typ	Max	Unit
Collector-base breakdown voltage	$V_{(BR)CBO}$	$I_C=0.1mA, I_E=0$	80			V
Collector-emitter breakdown	$V_{(BR)CEO}^*$	$I_C=10mA, I_B=0$	60			V
Emitter-base breakdown voltage	$V_{(BR)EBO}$	$I_E=0.01mA, I_C=0$	5			V
Collector cut-off current	I_{CBO}	$V_{CB}=80V, I_E=0$			0.1	μA
Emitter cut-off current	I_{EBO}	$V_{EB}=4V, I_C=0$			0.1	μA
DC current gain	$h_{FE(1)}^*$	$V_{CE}=2V, I_C=50mA$	75			
	$h_{FE(2)}^*$	$V_{CE}=2V, I_C=500mA$	75			
	$h_{FE(3)}^*$	$V_{CE}=2V, I_C=1A$	75			
	$h_{FE(4)}^*$	$V_{CE}=2V, I_C=2A$	40			
Collector-emitter saturation voltage	$V_{CE(sat)(1)}^*$	$I_C=2A, I_B=200mA$			0.5	V
	$V_{CE(sat)(2)}^*$	$I_C=1A, I_B=100mA$			0.3	V
Base-emitter saturation voltage	$V_{BE(sat)}^*$	$I_C=1A, I_B=100mA$			1.2	V
Base-emitter voltage	V_{BE}^*	$I_C=1A, V_{CE}=2V$			1	V
Transition frequency	f_T	$V_{CE}=5V, I_C=50mA, f=100MHz$	75			MHz

*Pulse test: pulse width $\leq 300\mu s$, duty cycle $\leq 2.0\%$.

Typical Characteristics

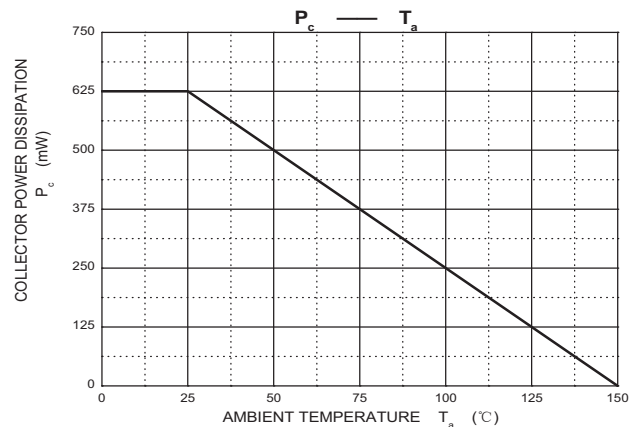
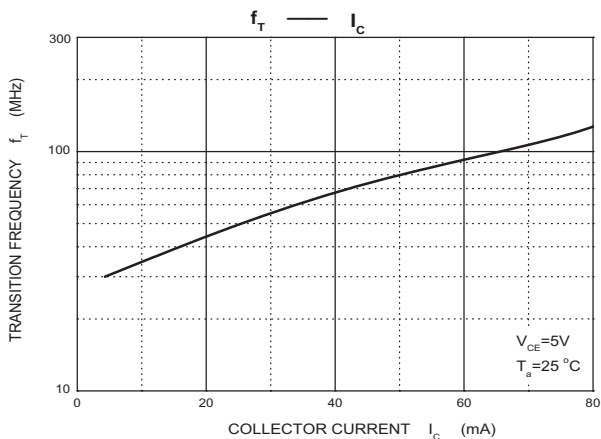
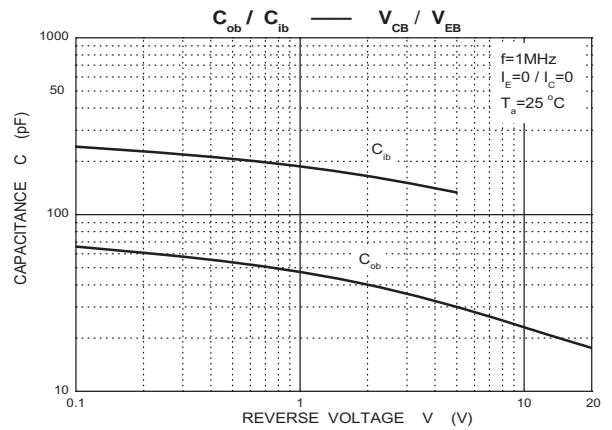
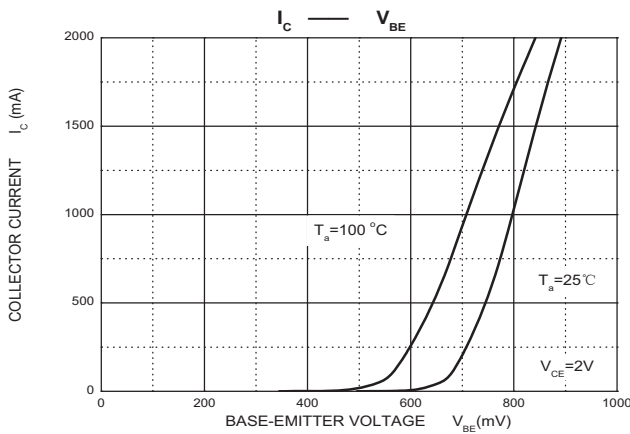
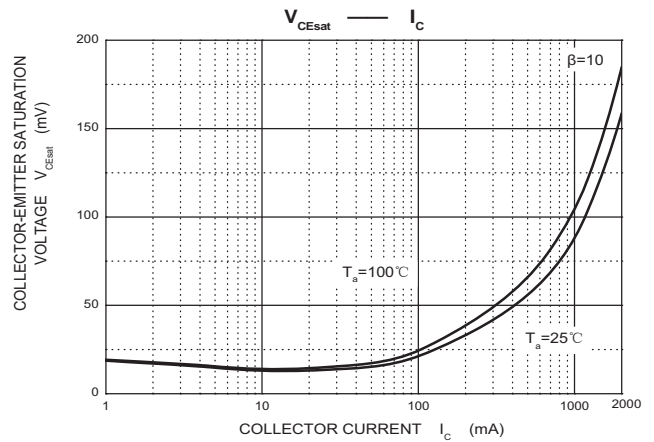
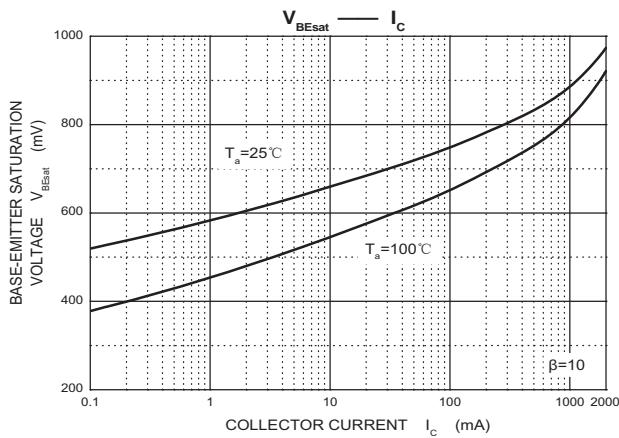
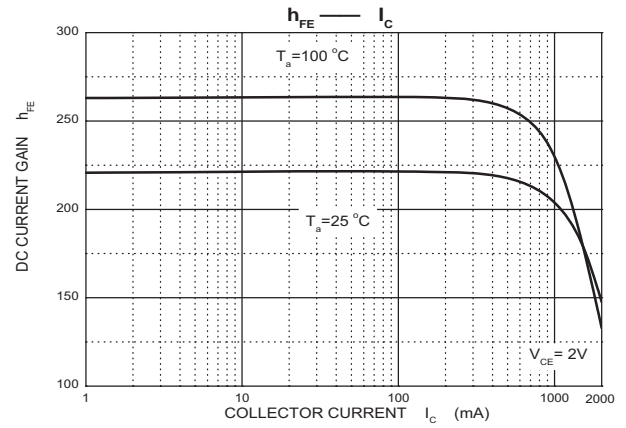
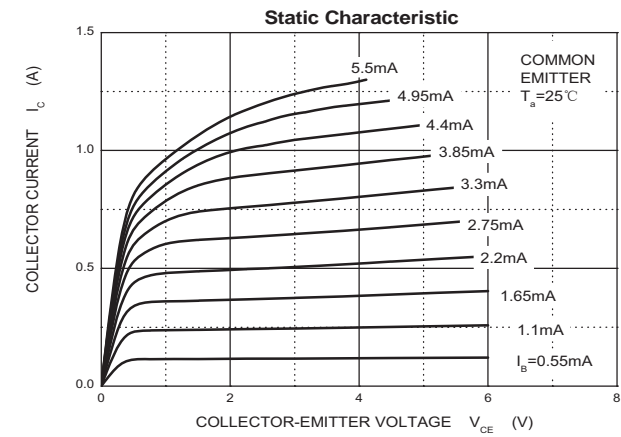

TO-92 Package Outline Dimensions

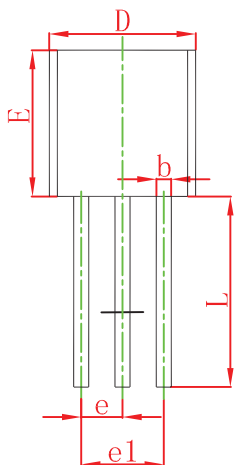
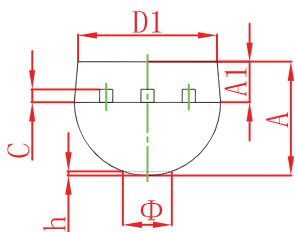

Symbol	Dimensions In Millimeters		Dimensions In Inches	
	Min	Max	Min	Max
A	3.300	3.700	0.130	0.146
A1	1.100	1.400	0.043	0.055
b	0.380	0.550	0.015	0.022
c	0.360	0.510	0.014	0.020
D	4.300	4.700	0.169	0.185
D1	3.430		0.135	
E	4.300	4.700	0.169	0.185
e	1.270 TYP		0.050 TYP	
e1	2.440	2.640	0.096	0.104
L	14.100	14.500	0.555	0.571
Φ		1.600		0.063
h	0.000	0.380	0.000	0.015

TO-92 Suggested Pad Layout

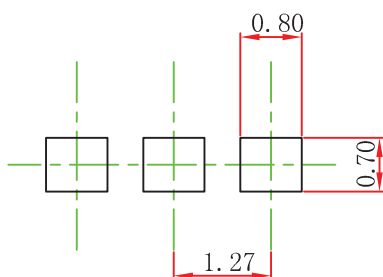

Note:

1. Controlling dimension: in millimeters.
2. General tolerance: $\pm 0.05\text{mm}$.
3. The pad layout is for reference purposes only.

TO-92 Tape and Reel

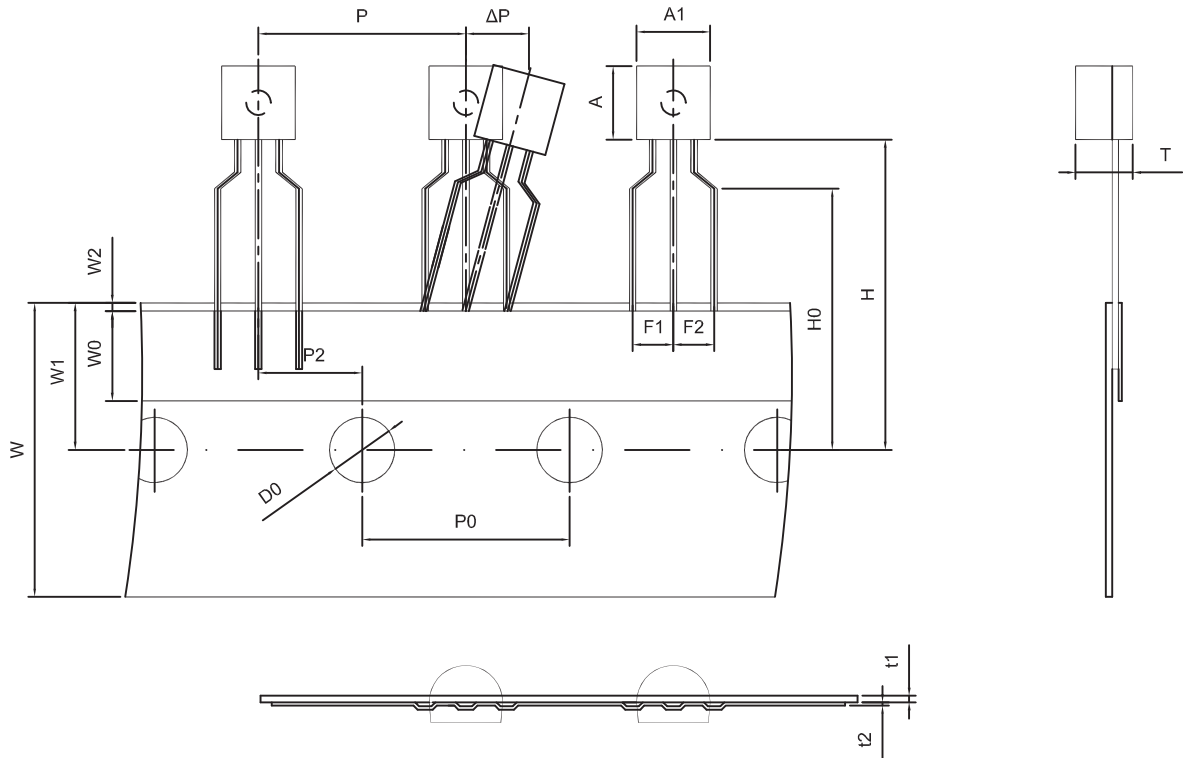

Dimensions are in millimeter								
A1	A	T	P	P0	P2	F1	F2	W
4.5	4.5	3.5	12.7	12.7	6.35	2.5	2.5	18.0
W0	W1	W2	H	H0	D0	t1	t2	ΔP
6.0	9.0	1.0 MAX.	19.0	16.0	4.0	0.4	0.2	0

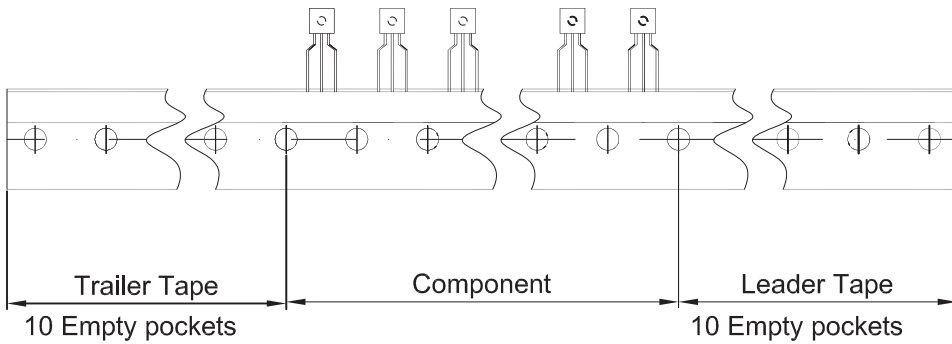

Package	Box	Box Size(mm)	Carton	Carton Size(mm)
TO-92	2000 pcs	333×162×43	20,000 pcs	350×340×250