



DONGGUAN NANJING ELECTRONICS LTD.,

## TO-92 Plastic-Encapsulate Transistors

### MPS751 TRANSISTOR (PNP)

#### ● FEATURES

Switching and Amplifier Applications

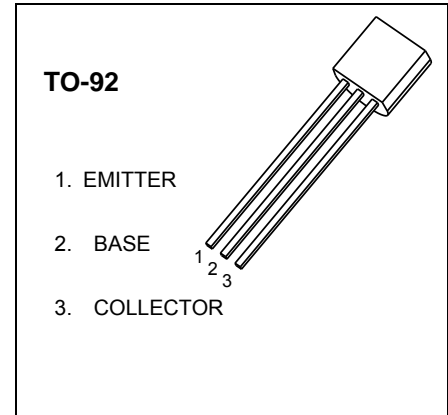

#### MARKING

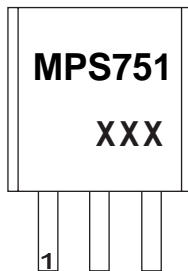

MPS751=Device code  
XXX=Code

#### Equivalent Circuit

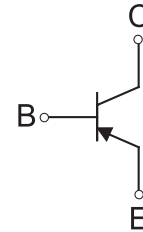

#### ORDERING INFORMATION

Part Number	Package	Packing Method	Pack Quantity
MPS751	TO-92	Bulk	1000pcs/Bag
MPS751-TA	TO-92	Tape	2000pcs/Box

#### MAXIMUM RATINGS ( $T_a=25^\circ\text{C}$ unless otherwise noted)

Symbol	Parameter	Value	Unit
$V_{CBO}$	Collector-Base Voltage	-80	V
$V_{CEO}$	Collector-Emitter Voltage	-60	V
$V_{EBO}$	Emitter-Base Voltage	-5	V
$I_C$	Collector Current -Continuous	-2	A
$P_C$	Collector Dissipation	0.625	W
$R_{\theta JA}$	Thermal Resistance from Junction to Ambient	200	$^\circ\text{C/W}$
$T_J$	Junction Temperature	150	$^\circ\text{C}$
$T_{stg}$	Storage Temperature	-55-150	$^\circ\text{C}$

## ELECTRICAL CHARACTERISTICS

$T_a=25^\circ\text{C}$  unless otherwise specified

Parameter	Symbol	Test conditions	Min	Typ	Max	Unit
Collector-base breakdown voltage	$V_{(BR)CBO}$	$I_C=-100\mu\text{A}, I_E=0$	-80			V
Collector-emitter breakdown voltage	$V_{(BR)CEO}^*$	$I_C=-10\text{mA}, I_B=0$	-60			V
Emitter-base breakdown voltage	$V_{(BR)EBO}$	$I_E=-10\mu\text{A}, I_C=0$	-5			V
Collector cut-off current	$I_{CBO}$	$V_{CB}=-80\text{V}, I_E=0$			-0.1	$\mu\text{A}$
Emitter cut-off current	$I_{EBO}$	$V_{EB}=-4\text{V}, I_C=0$			-0.1	$\mu\text{A}$
DC current gain	$h_{FE(1)}^*$	$V_{CE}=-2\text{V}, I_C=-50\text{mA}$	75			
	$h_{FE(2)}^*$	$V_{CE}=-2\text{V}, I_C=-500\text{mA}$	75			
	$h_{FE(3)}^*$	$V_{CE}=-2\text{V}, I_C=-1\text{A}$	75			
	$h_{FE(4)}^*$	$V_{CE}=-2\text{V}, I_C=-2\text{A}$	40			
Collector-emitter saturation voltage	$V_{CE(sat)}^*$	$I_C=-2\text{A}, I_B=-200\text{mA}$			-0.5	V
		$I_C=-1\text{A}, I_B=-100\text{mA}$			-0.3	
Base-emitter saturation voltage	$V_{BE(sat)}^*$	$I_C=-1\text{A}, I_B=-100\text{mA}$			-1.2	V
Base-emitter on voltage	$V_{BE(on)}^*$	$V_{CE}=-2\text{V}, I_C=-1\text{A}$			-1	V
Transition frequency	$f_T$	$V_{CE}=-5\text{V}, I_C=-50\text{mA}, f=100\text{MHz}$	75			MHz

\* Pulse Test: Pulse Width  $\leq 300\mu\text{s}$ , Duty Cycle = 2.0%.

# Typical Characteristics

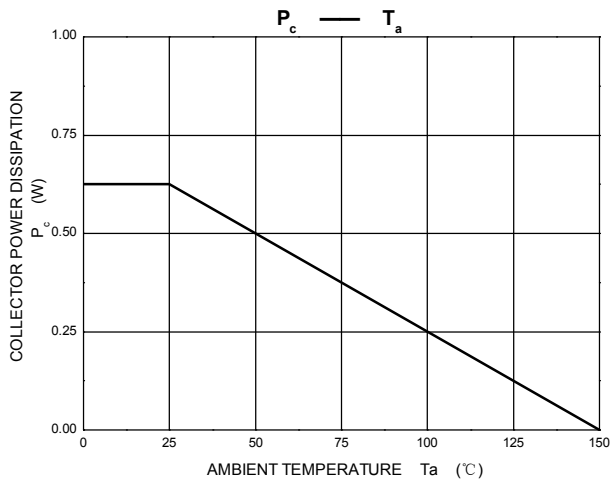
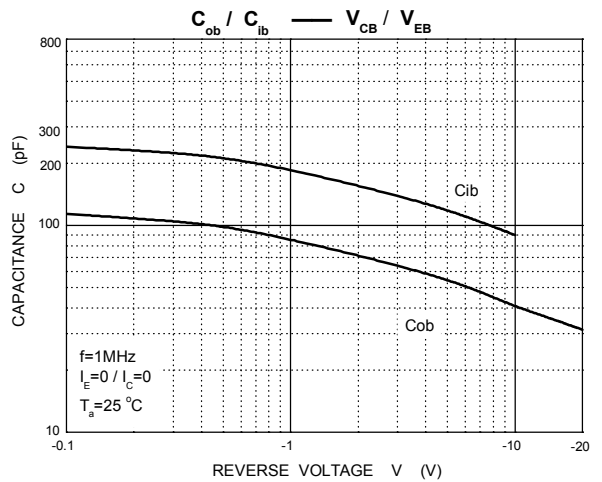
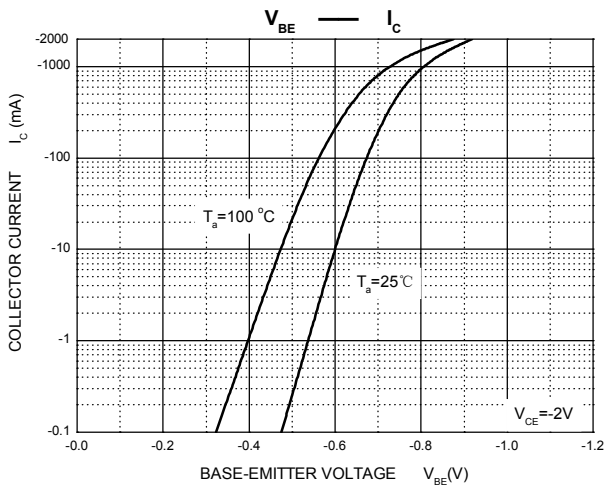
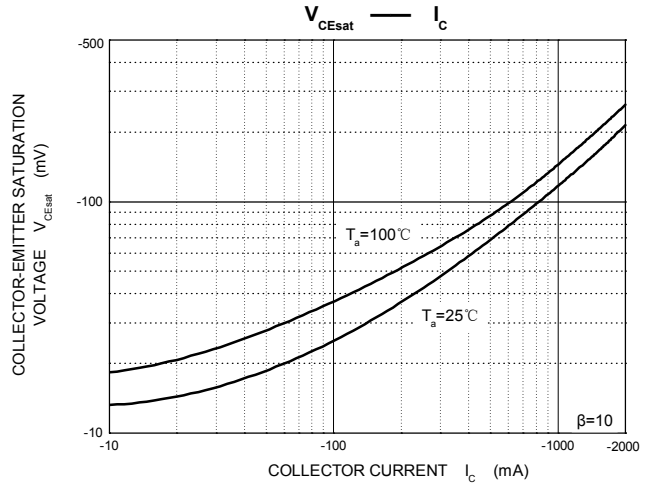
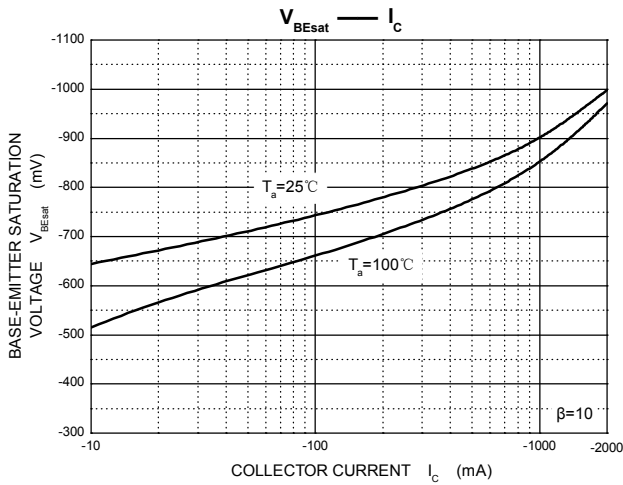
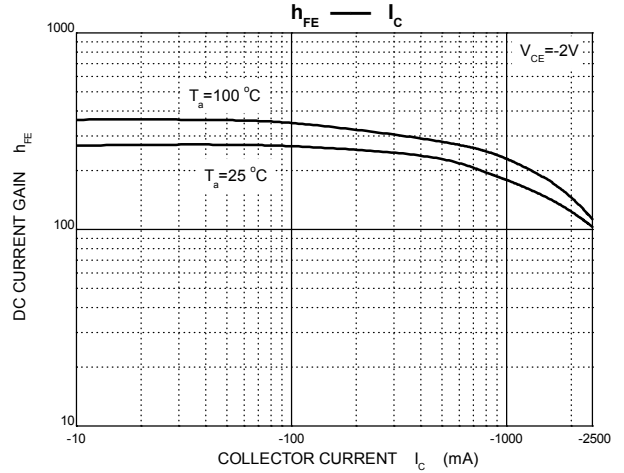
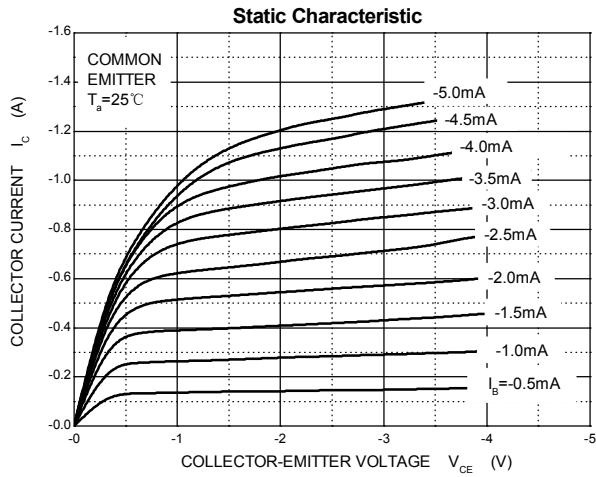

## TO-92 Package Outline Dimensions



Symbol	Dimensions In Millimeters		Dimensions In Inches	
	Min	Max	Min	Max
A	3.300	3.700	0.130	0.146
A1	1.100	1.400	0.043	0.055
b	0.380	0.550	0.015	0.022
c	0.360	0.510	0.014	0.020
D	4.300	4.700	0.169	0.185
D1	3.430		0.135	
E	4.300	4.700	0.169	0.185
e	1.270 TYP		0.050 TYP	
e1	2.440	2.640	0.096	0.104
L	14.100	14.500	0.555	0.571
Φ		1.600		0.063
h	0.000	0.380	0.000	0.015

## TO-92 Suggested Pad Layout

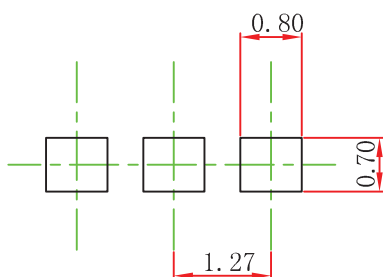

### Note:

1. Controlling dimension: in millimeters.
2. General tolerance:  $\pm 0.05\text{mm}$ .
3. The pad layout is for reference purposes only.

# TO-92 Tape and Reel



Dimiensions are in millimeter								
A1	A	T	P	P0	P2	F1	F2	W
4.5	4.5	3.5	12.7	12.7	6.35	2.5	2.5	18.0
W0	W1	W2	H	H0	D0	t1	t2	$\Delta P$
6.0	9.0	1.0 MAX.	19.0	16.0	4.0	0.4	0.2	0

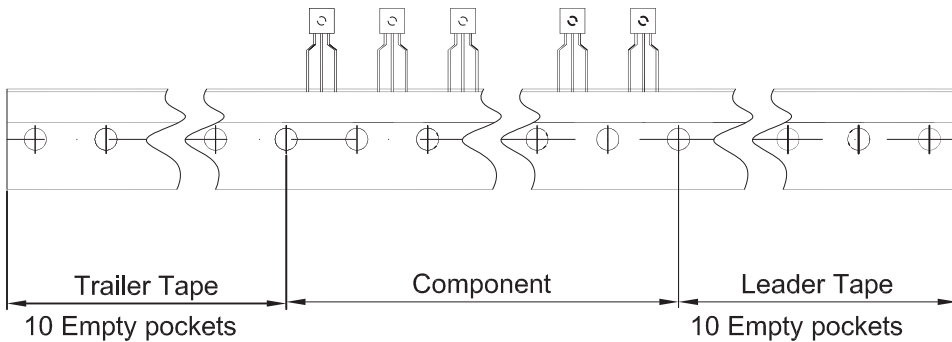

Package	Box	Box Size(mm)	Carton	Carton Size(mm)
TO-92	2000 pcs	333×162×43	20,000 pcs	350×340×250