



DONGGUAN NANJING ELECTRONICS LTD.,

TO-92 Plastic-Encapsulate Transistors

MPS2222A TRANSISTOR (NPN)

FEATURE

- Complementary NPN Type available (MPS2907A)

TO-92

1. EMITTER
2. BASE
3. COLLECTOR

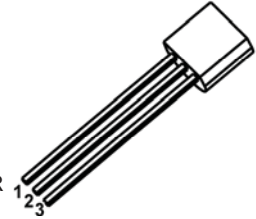

MARKING

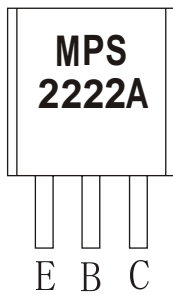

MPS2222A=Device code

Equivalent Circuit

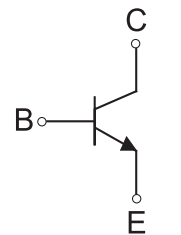

ORDERING INFORMATION

Part Number	Package	Packing Method	Pack Quantity
MPS2222A	T, -92	Bulk	1000pcs/Bag
MPS2222A-TA	T, -92	Tape	2000pcs/Box

MAXIMUM RATINGS (T_a=25°C unless otherwise noted)

Symbol	Parameter	Value	Unit
V _{CB0}	Collector-Base Voltage	75	V
V _{CEO}	Collector-Emitter Voltage	40	V
V _{EBO}	Emitter-Base Voltage	6	V
I _C	Collector Current -Continuous	0.6	A
P _D	Collector Power Dissipation	625	mW
R _{θJA}	Thermal Resistance from Junction to Ambient	200	°C /W
T _J , T _{stg}	Operation Junction and Storage Temperature Range	-55~+150	°C

ELECTRICAL CHARACTERISTICS

$T_a=25^\circ\text{C}$ unless otherwise specified

Parameter	Symbol	Test conditions	Min	Max	Unit
Collector-base breakdown voltage	$V_{(BR)CBO}$	$I_C=10\mu\text{A}, I_E=0$	75		V
Collector-emitter breakdown voltage	$V_{(BR)CEO}$	$I_C=10\text{mA}, I_B=0$	40		V
Emitter-base breakdown voltage	$V_{(BR)EBO}$	$I_E=10\mu\text{A}, I_C=0$	6		V
Collector cut-off current	I_{CBO}	$V_{CB}=60\text{V}, I_E=0$		10	nA
Collector cut-off current	I_{CEX}	$V_{CE}=60\text{V}, V_{EB(off)}=3\text{V}$		10	nA
Emitter cut-off current	I_{EBO}	$V_{EB}=3\text{V}, I_C=0$		100	nA
DC current gain	$h_{FE(1)}$	$V_{CE}=10\text{V}, I_C=150\text{mA}$	100	300	
	$h_{FE(2)}$	$V_{CE}=10\text{V}, I_C=0.1\text{mA}$	40		
	$h_{FE(3)}^*$	$V_{CE}=10\text{V}, I_C=500\text{mA}$	42		
Collector-emitter saturation voltage	$V_{CE(sat)(1)}^*$	$I_C=500\text{mA}, I_B=50\text{mA}$		0.6	V
	$V_{CE(sat)(2)}^*$	$I_C=150\text{mA}, I_B=15\text{mA}$		0.3	V
Base-emitter saturation voltage	$V_{BE(sat)}^*$	$I_C=500\text{mA}, I_B=50\text{mA}$		1.2	V
Delay time	t_d	$V_{CC}=30\text{V}, V_{EB(off)}=-0.5\text{V},$		10	nS
Rise time	t_r	$I_C=150\text{mA}, I_{B1}=15\text{mA}$		25	nS
Storage time	t_s	$V_{CC}=30\text{V}, I_C=150\text{mA}, I_{B1}=I_{B2}=15\text{mA}$		225	nS
Fall time	t_f			60	nS
Transition frequency	f_T	$V_{CE}=20\text{V}, I_C=20\text{mA}, f=100\text{MHz}$	300		MHz

* pulse test

CLASSIFICATION OF $h_{FE(1)}$

Rank	L	H
Range	100-200	200-300

Typical Characteristics

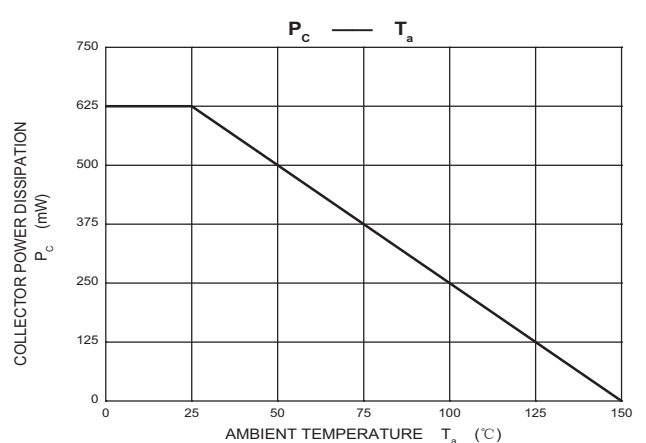
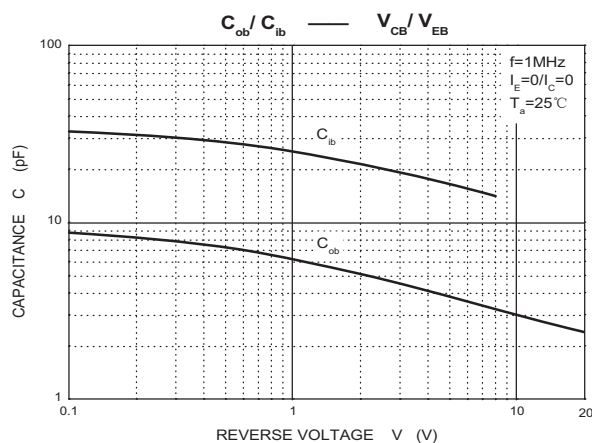
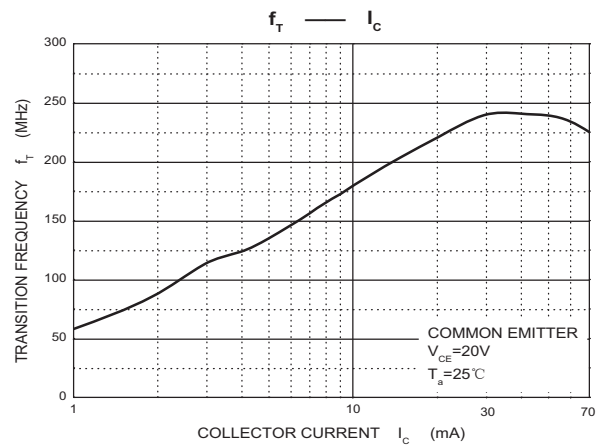
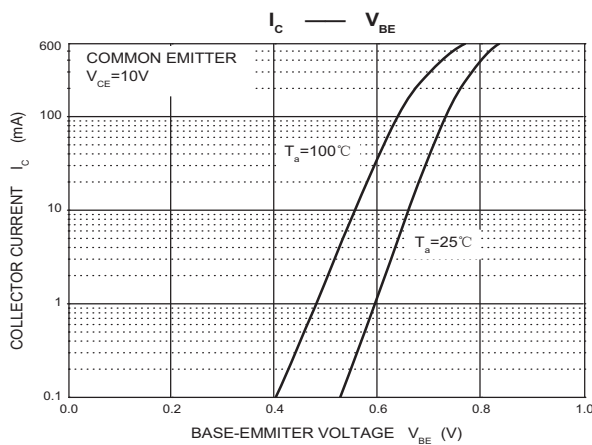
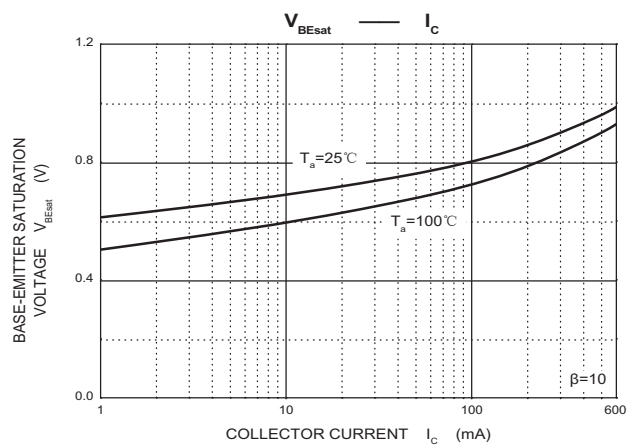
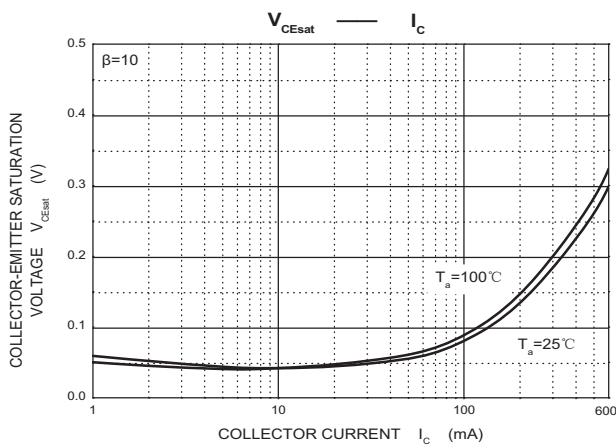
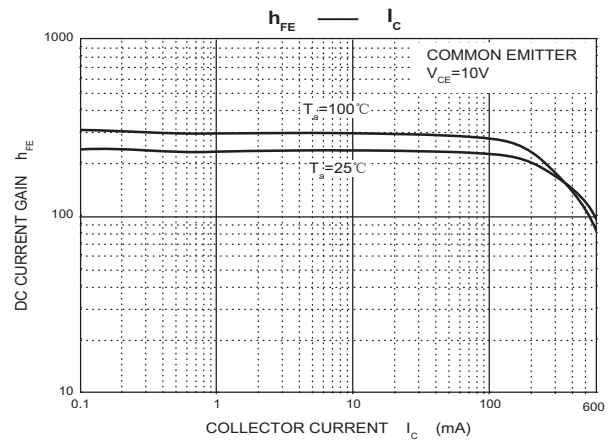
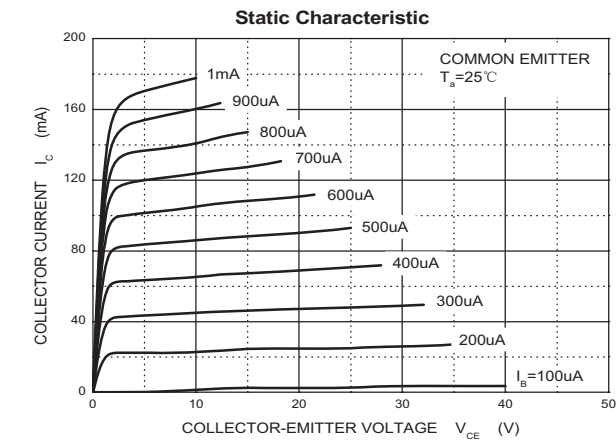

TO-92 Package Outline Dimensions

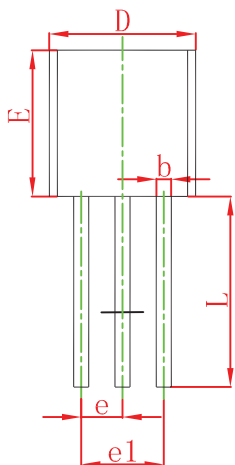
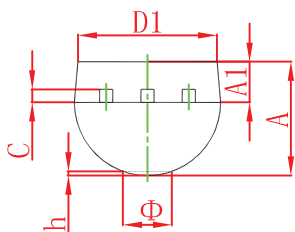

Symbol	Dimensions In Millimeters		Dimensions In Inches	
	Min	Max	Min	Max
A	3.300	3.700	0.130	0.146
A1	1.100	1.400	0.043	0.055
b	0.380	0.550	0.015	0.022
c	0.360	0.510	0.014	0.020
D	4.300	4.700	0.169	0.185
D1	3.430		0.135	
E	4.300	4.700	0.169	0.185
e	1.270 TYP		0.050 TYP	
e1	2.440	2.640	0.096	0.104
L	14.100	14.500	0.555	0.571
Φ		1.600		0.063
h	0.000	0.380	0.000	0.015

TO-92 Suggested Pad Layout

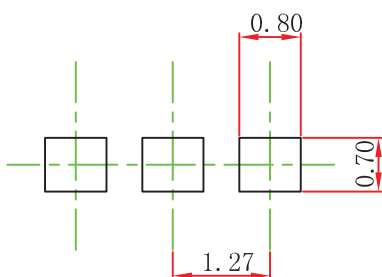

Note:

1. Controlling dimension: in millimeters.
2. General tolerance: $\pm 0.05\text{mm}$.
3. The pad layout is for reference purposes only.

TO-92 Tape and Reel

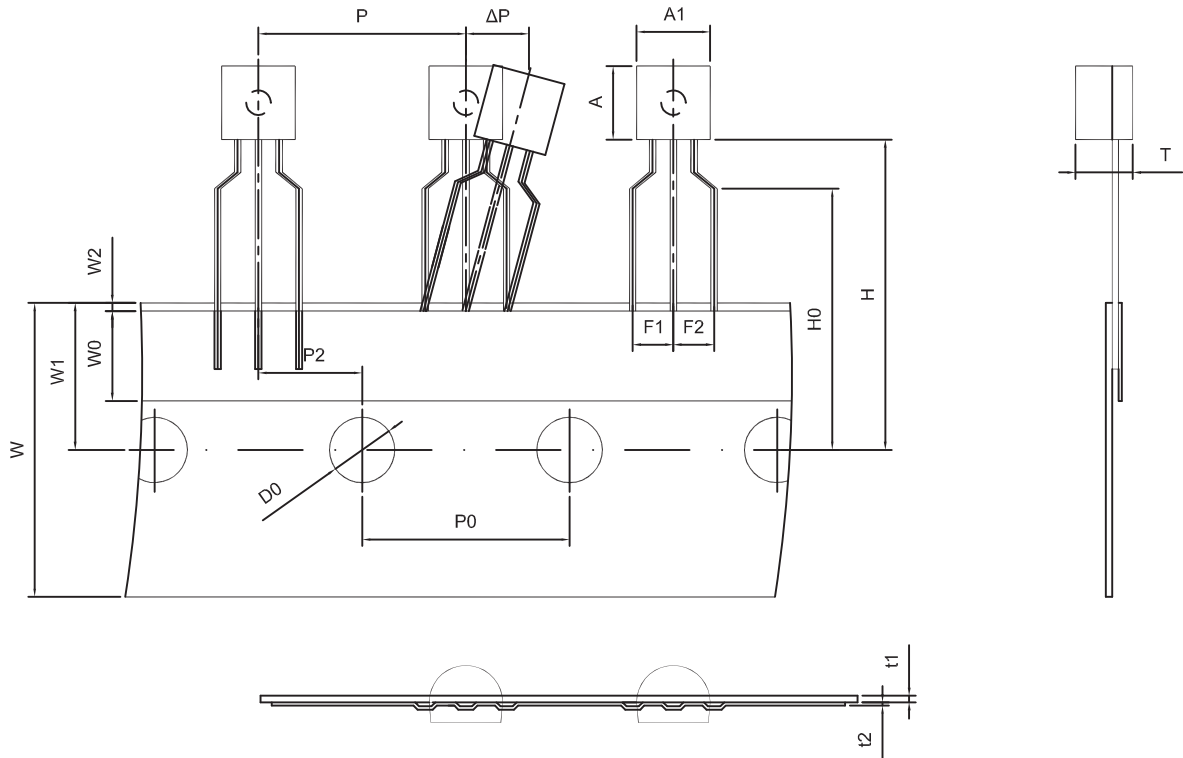

Dimiensions are in millimeter								
A1	A	T	P	P0	P2	F1	F2	W
4.5	4.5	3.5	12.7	12.7	6.35	2.5	2.5	18.0
W0	W1	W2	H	H0	D0	t1	t2	ΔP
6.0	9.0	1.0 MAX.	19.0	16.0	4.0	0.4	0.2	0

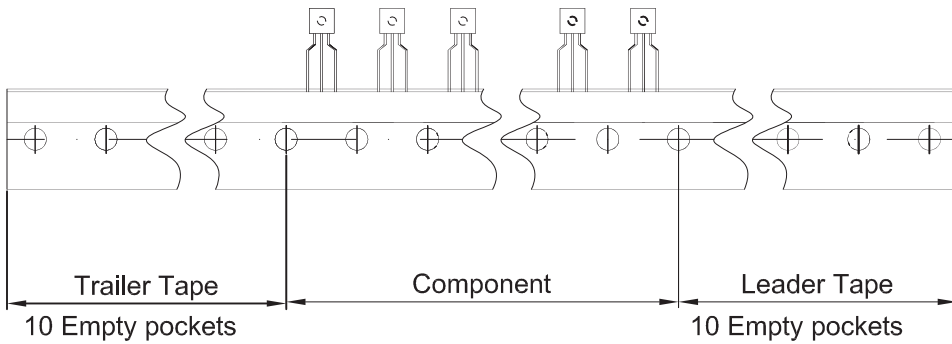

Package	Box	Box Size(mm)	Carton	Carton Size(mm)
TO-92	2000 pcs	333×162×43	20,000 pcs	350×340×250