



DONGGUAN NANJING ELECTRONICS LTD.,

TO-92 Plastic-Encapsulate Transistors

MPSA17 TRANSISTOR (NPN)

FEATURES

- High $V_{(BR)EBO}$: 12V

TO-92

1. EMITTER

2. BASE

3. COLLECTOR

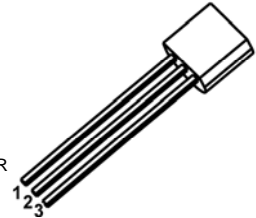

MARKING

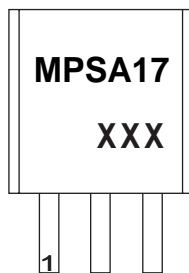

MPSA17 = Device code

XXX = Code

Equivalent Circuit

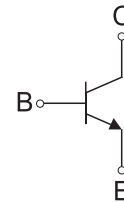

ORDERING INFORMATION

Part Number	Package	Packing Method	Pack Quantity
MPSA17	TO-92	Bulk	1000pcs/Bag
MPSA17-TA	TO-92	Tape	2000pcs/Box

MAXIMUM RATINGS ($T_a=25^\circ\text{C}$ unless otherwise noted)

Symbol	Parameter	Value	Unit
V_{CEO}	Collector-Ease Voltage	40	V
V_{EBO}	Emitter-Base Voltage	12	V
I_c	Collector Current -Continuous	0.1	A
P_c	Collector Power Dissipation	300	mW
T_J, T_{stg}	Operation Junction and Storage Temperature Range	-55 to +150	$^\circ\text{C}$

ELECTRICAL CHARACTERISTICS

$T_a=25\text{ }^\circ\text{C}$ unless otherwise specified

Parameter	Symbol	Test conditions	Min	Max	Unit
Collector-emitter breakdown voltage	$V_{(BR)CEO}$	$I_C=1\text{mA}, I_E=0$	40		V
Emitter-base breakdown voltage	$V_{(BR)EBO}$	$I_E=100\mu\text{A}, I_C=0$	12		V
Collector cut-off current	I_{CBO}	$V_{CB}=30\text{V}, I_E=0$		0.1	μA
Emitter cut-off current	I_{EBO}	$V_{EB}=10\text{V}, I_C=0$		0.1	μA
DC current gain	h_{FE}	$V_{CE}=10\text{V}, I_C=5\text{mA}$	200	800	
Collector-emitter saturation voltage	$V_{CE(sat)}$	$I_C=10\text{mA}, I_B=1\text{mA}$		0.25	V
Transition frequency	f_T	$V_{CE}=10\text{V}, I_C=5\text{mA}, f=100\text{MHz}$	80		MHz
Collector output capacitance	C_{ob}	$V_{CB}=10\text{V}, I_E=0, f=1\text{MHz}$		4	pF

TO-92 Package Outline Dimensions

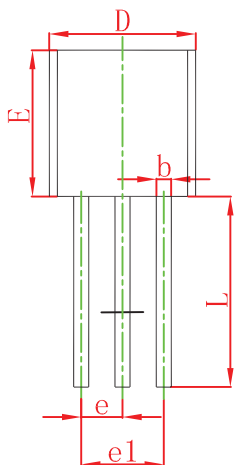
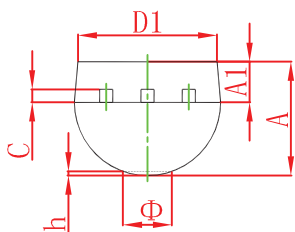

Symbol	Dimensions In Millimeters		Dimensions In Inches	
	Min	Max	Min	Max
A	3.300	3.700	0.130	0.146
A1	1.100	1.400	0.043	0.055
b	0.380	0.550	0.015	0.022
c	0.360	0.510	0.014	0.020
D	4.300	4.700	0.169	0.185
D1	3.430		0.135	
E	4.300	4.700	0.169	0.185
e	1.270 TYP		0.050 TYP	
e1	2.440	2.640	0.096	0.104
L	14.100	14.500	0.555	0.571
Φ		1.600		0.063
h	0.000	0.380	0.000	0.015

TO-92 Suggested Pad Layout

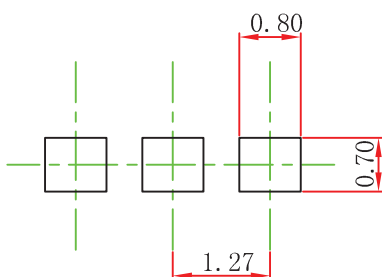

Note:

1. Controlling dimension: in millimeters.
2. General tolerance: $\pm 0.05\text{mm}$.
3. The pad layout is for reference purposes only.

TO-92 Tape and Reel

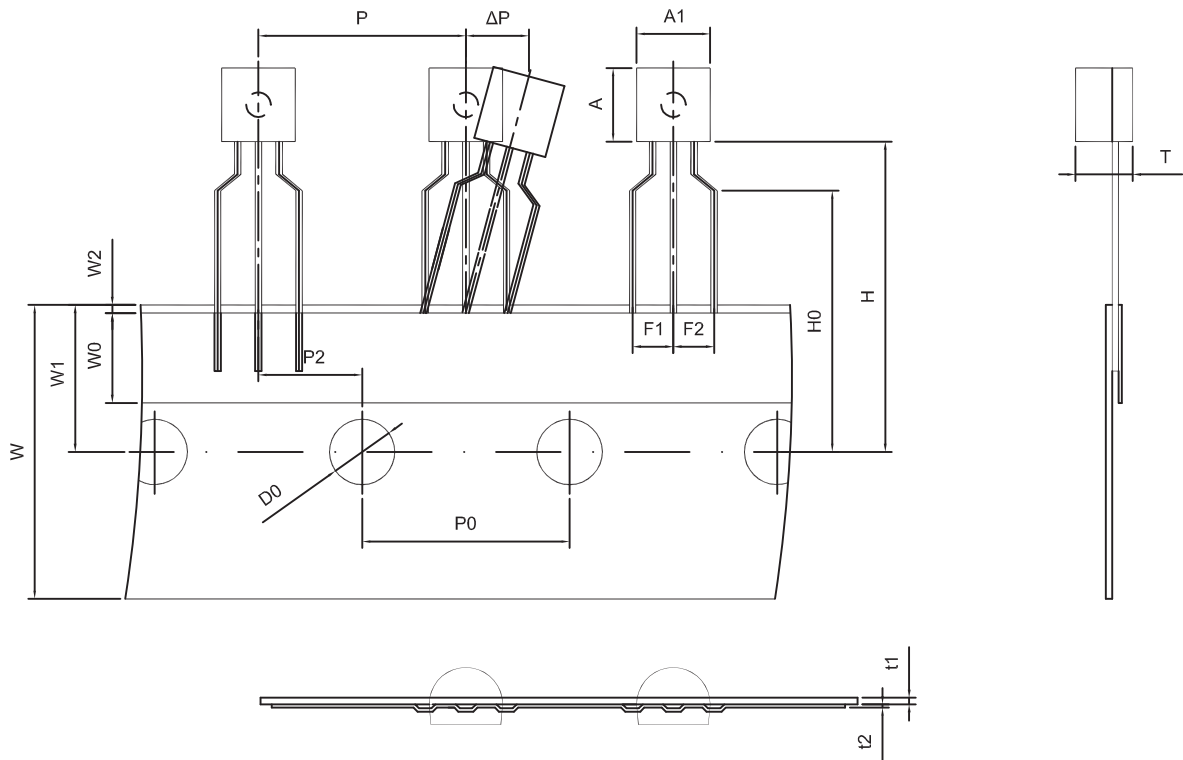

Dimiensions are in millimeter								
A1	A	T	P	P0	P2	F1	F2	W
4.5	4.5	3.5	12.7	12.7	6.35	2.5	2.5	18.0
W0	W1	W2	H	H0	D0	t1	t2	ΔP
6.0	9.0	1.0 MAX.	19.0	16.0	4.0	0.4	0.2	0

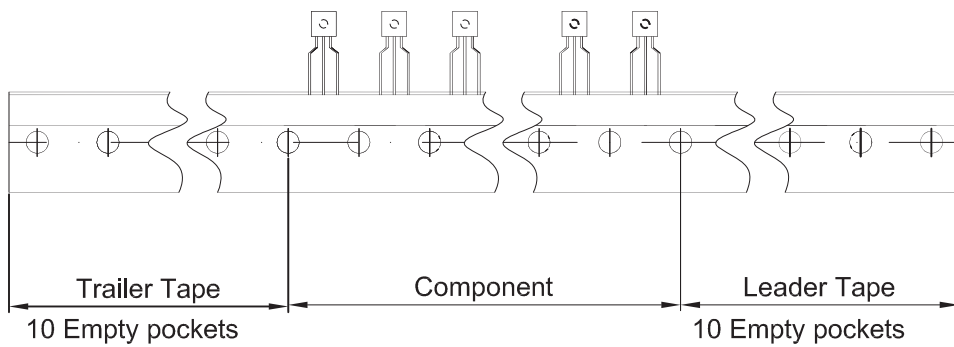

Package	Box	Box Size(mm)	Carton	Carton Size(mm)
TO-92	2000 pcs	333×162×43	20,000 pcs	350×340×250