



DONGGUAN NANJING ELECTRONICS LTD.,
ITO-220AC Plastic-Encapsulate Diode

MURF860 HYPERFAST RECTIFIER,FRED

MAIN CHARACTERISTICS

I_O	8A
V_{RRM}	600V
T_{rr}	25ns
T_j	175°C
$V_{F(typ)}$	1.05V(@$T_j=150°C$)

FEATURES

- Ultrafast Recovery Times and Low Recovery Loss
- Low Forward Voltage
- Low Reverse Leakage Current

APPLICATIONS

Specifically designed to improve efficiency of PFC and output rectification stages of EV / HEV battery charging stations, booster stage of solar inverters and UPS applications, these devices are perfectly matched to operate with MOSFETs or high speed IGBTs.

MARKING

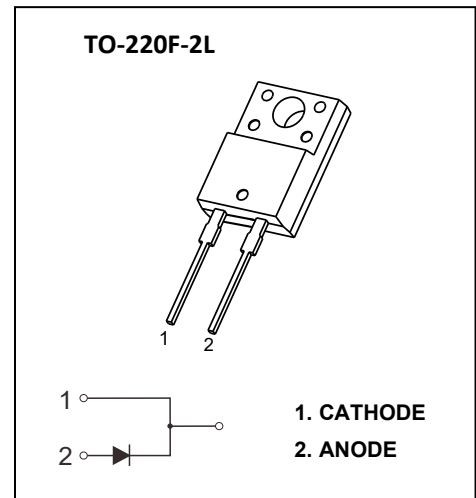
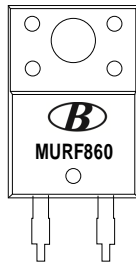

MAXIMUM RATINGS ($T_c=25°C$ unless otherwise noted)

Symbol	Parameter	MURF8H60	Unit
V_{RRM}	Peak Repetitive Reverse Voltage	600	V
V_R	DC Blocking Voltage		
$I_{F(AV)}$	Average Forward Current($T_c=120°C$)	8	A
$I_{F(RMS)}$	RMS Forward Current($T_c=120°C$)	11	A
I_{FSM}	Non-Repetitive Surge Forward Current (8.3ms)	136	A
P_D	Power dissipation	40	W
$R_{\theta JC}$	Thermal Resistance From Junction to Case	3.75	°C/W
T_j	Operating Junction Temperature Range	-55 ~ +175	°C
T_{stg}	Storage Temperature Range	-55 ~ +175	°C

Typical Characteristics

ELECTRICAL CHARACTERISTICS ($T_c=25^\circ\text{C}$ unless otherwise specified)

Symbol	Parameter	Test Conditions	Min.	Typ.	Max.	Unit
$V_{(BR)}$	Reverse Voltage	$I_R=100\mu\text{A}$	600			V
I_R	Reverse Current	$V_R=600\text{V}$	$T_j=25^\circ\text{C}$		10	μA
			$T_j=150^\circ\text{C}$		500	μA
V_F	Forward Voltage	$I_F=8\text{A}$	$T_j=25^\circ\text{C}$	1.20	1.3	V
			$T_j=150^\circ\text{C}$		1.05	V
C_{tot}	Total Capacitance	$V_R=200\text{V}, f=1\text{MHz}$		8		pF
trr	Reverse Recovery time	$I_F=0.5\text{A}, I_R=1\text{A}, I_{rr}=0.25\text{A}$		34		ns
		$I_F=1\text{A}, V_R=30\text{V}, di_F/dt=200\text{A}/\mu\text{s}$		25		ns

ELECTRICAL CHARACTERISTICS ($T_c=25^\circ\text{C}$ unless otherwise specified)

Symbol	Parameter	Test Conditions	Min.	Typ.	Max.	Unit
trr	Reverse Recovery Time	$I_F=8\text{A}, V_R=400\text{V}, di_F/dt=200\text{A}/\mu\text{s}$		68		ns
I_{RRM}	Max. Reverse Recovery Current			5		A
Qrr	Reverse Recovery Charge			185		nC
trr	Reverse Recovery Time	$I_F=8\text{A}, V_R=400\text{V}, di_F/dt=200\text{A}/\mu\text{s}, T_j=125^\circ\text{C}$		97		ns
I_{RRM}	Max. Reverse Recovery Current			8		A
Qrr	Reverse Recovery Charge			433		nC
trr	Reverse Recovery Time	$I_F=8\text{A}, V_R=400\text{V}, di_F/dt=500\text{A}/\mu\text{s}, T_j=125^\circ\text{C}$		74		ns
I_{RRM}	Max. Reverse Recovery Current			13		A
Qrr	Reverse Recovery Charge			562		nC

Typical Characteristics

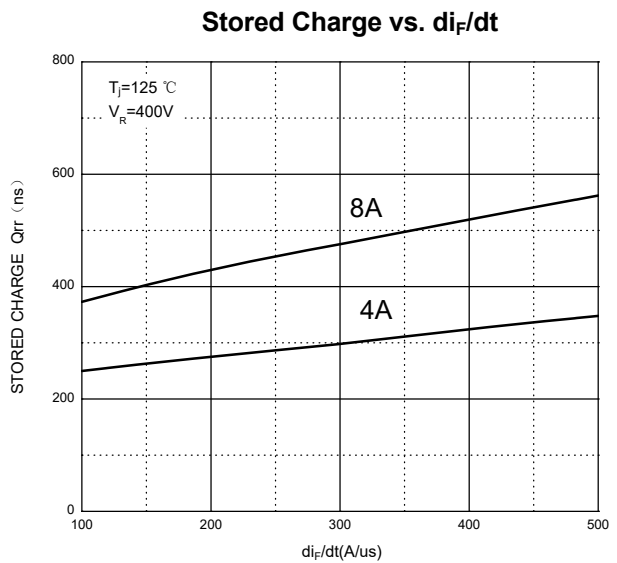
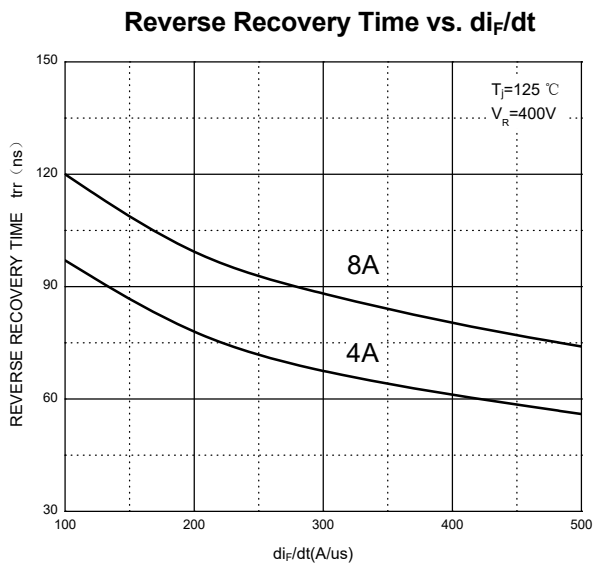
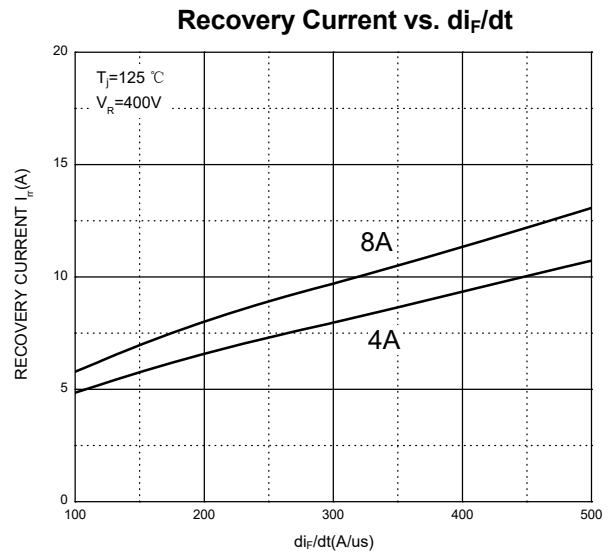
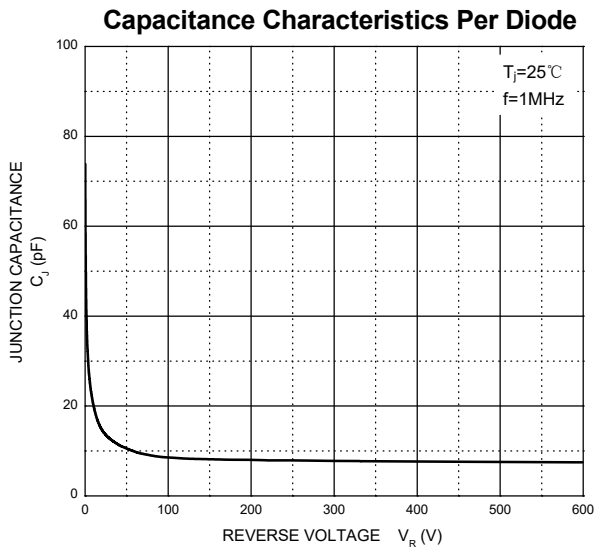
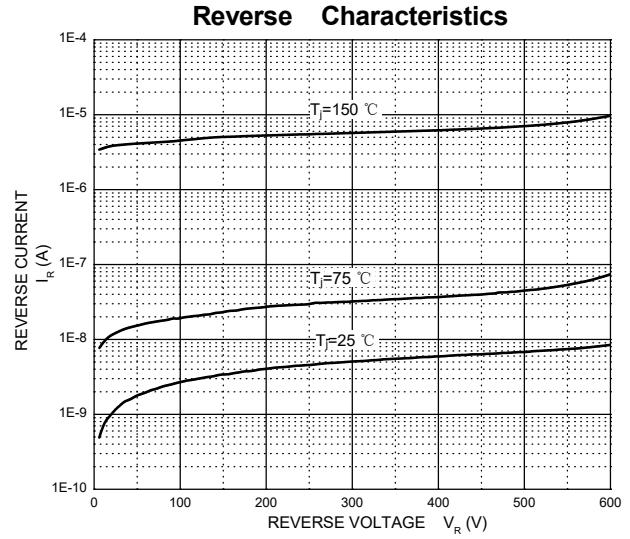
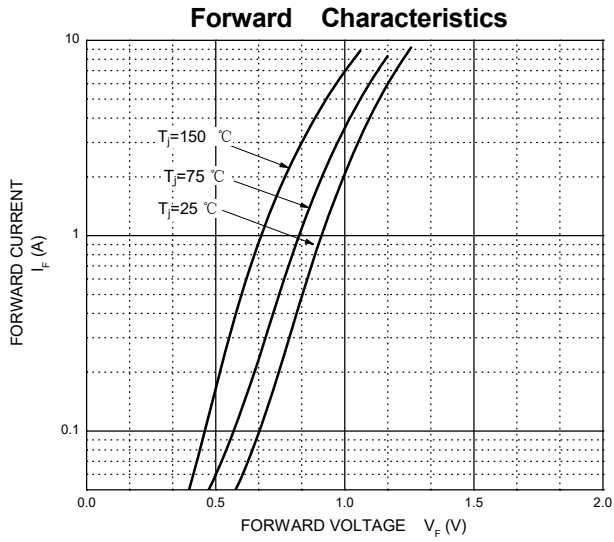

Typical Characteristics

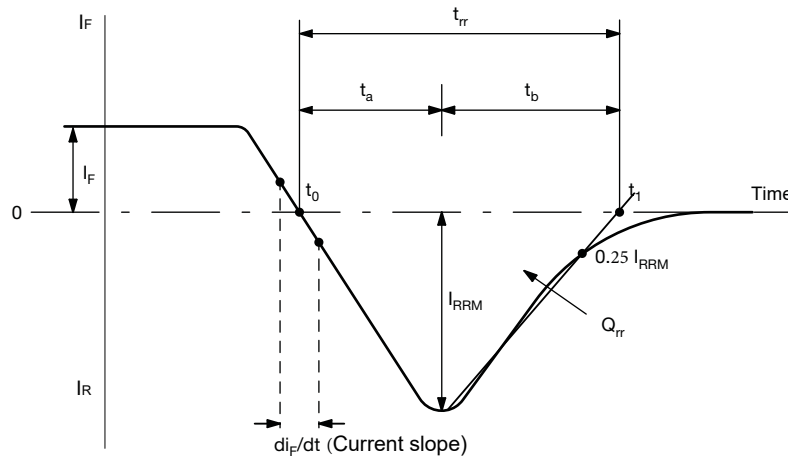

Reverse Recovery Waveform and Definitions

MURF8H60 Transient Thermal Impedance, Junction-Case

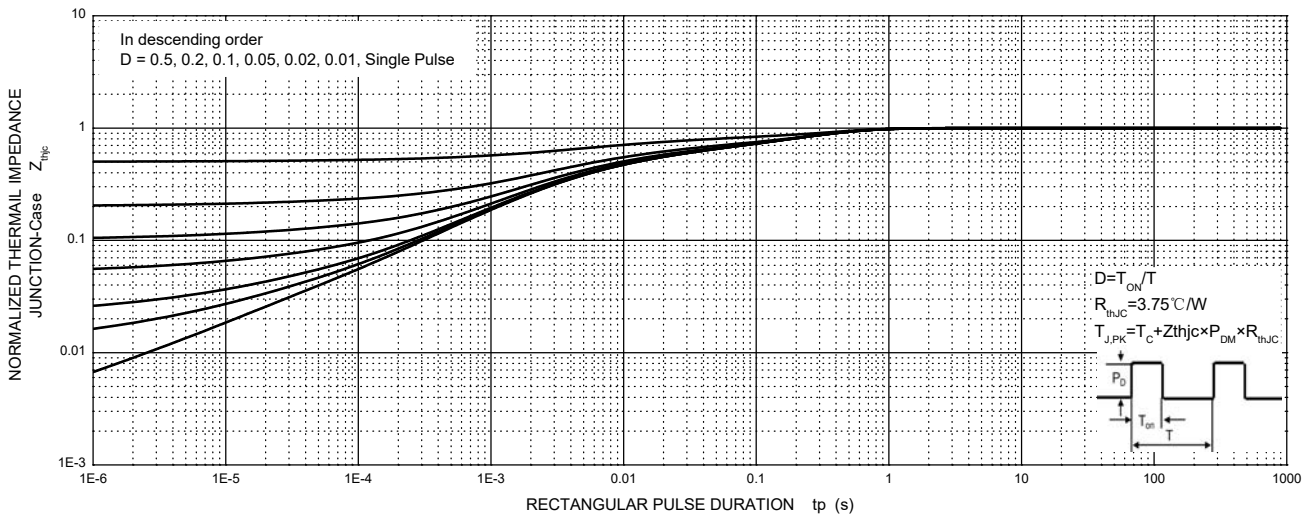

ITO-220AC Package Outline Dimensions

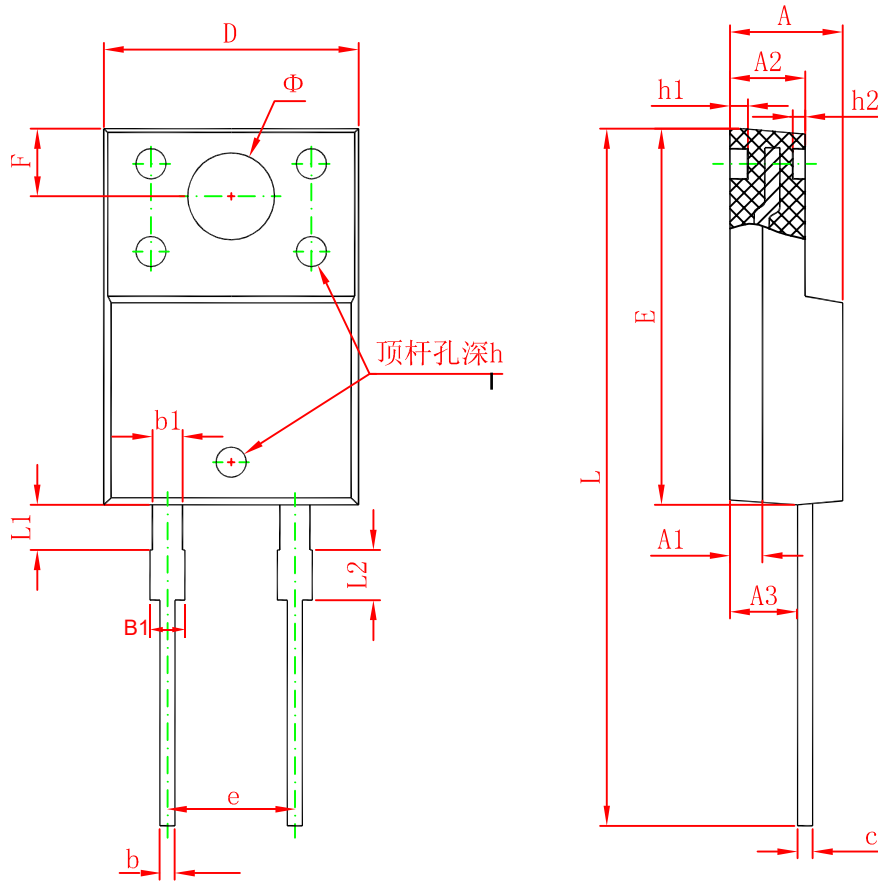

Symbol			Dimensions In Inches	
	Min.	Max.	Min.	Max.
A	4.300	4.700	0.169	0.185
A1	1.200 REF.		0.047 REF.	
A2	2.800	3.200	0.110	0.126
A3	2.500	2.900	0.098	0.114
b	0.710	0.910	0.028	0.036
b1	1.100	1.350	0.043	0.053
B1	1.150	1.400	0.045	0.055
c	0.500	0.750	0.020	0.030
D	9.960	10.360	0.392	0.408
E	14.800	15.200	0.583	0.598
e	5.080 TYP.		0.200 TYP.	
F	2.700 REF.		0.106 REF.	
Φ	3.300 REF.		0.130 REF.	
h	0.000	0.300	0.000	0.012
h1	0.800 REF.		0.031 REF.	
h2	0.500 REF.		0.020 REF.	
L	28.000	28.400	1.102	1.118
L1	2.100	2.400	0.082	0.094
L2	1.300	1.700	0.051	0.066