



DONGGUAN NANJING ELECTRONICS LTD.,
SMC Plastic-Encapsulate Diodes

S8A THRU S8M General Purpose Rectifier Diodes

Features

- $I_{F(AV)}$ 8A
- V_{RRM} 50V-1000V
- High surge current capability
- Polarity: Color band denotes cathode

Applications

- Rectifier

Marking

- S8X
- X : From A To M

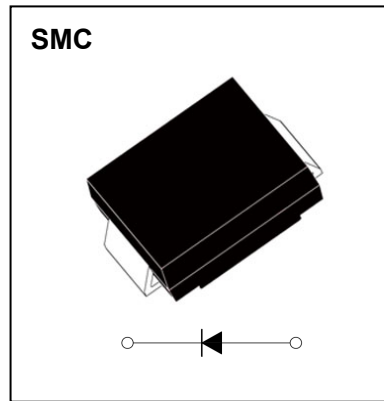

Limiting Values(Absolute Maximum Rating)

Item	Symbol	Unit	Test Conditions	S8						
				A	B	D	G	J	K	M
Repetitive Peak Reverse Voltage	V_{RRM}	V		50	100	200	400	600	800	1000
Maximum RMS Voltage	V_{RMS}	V		35	70	140	280	420	560	700
Average Forward Current	$I_{F(AV)}$	A	60Hz Half-sine wave, Resistance load, $T_L=110\text{C}$	5.0						
Surge(Non-repetitive)Forward Current	I_{FSM}	A	60Hz Half-sine wave, 1 cycle, $T_a=25\text{C}$	200						
Operation Junction and Storage Temperature Range	T_J, T_{STG}	$^{\circ}\text{C}$		-55 ~ +150						

Electrical Characteristics (T=25 $^{\circ}\text{C}$ Unless otherwise specified)

Item	Symbol	Unit	Test Condition	S8					
				A	B	D	G	J	K
Peak Forward Voltage	V_F	V	$I_F=8.0\text{A}$	0.98					
Peak Reverse Current	I_{RRM1}	μA	$V_{RM}=V_{RRM}$	$T_a=25^{\circ}\text{C}$					
	I_{RRM2}			$T_a=125^{\circ}\text{C}$					
Thermal Resistance(Typical)	$R_{\theta J-A}$	$^{\circ}\text{C}/\text{W}$	Between junction and ambient	47					
	$R_{\theta J-L}$		Between junction and terminal	13					
Maximum reverse recovery time	t_{rr}	ns	$I_F=0.5\text{A}, I_R=1.0\text{A}, I_{rr}=0.25\text{A}$	2700					

Notes:

Thermal resistance from junction to ambient and from junction to lead mounted on P.C.B. with 0.30" x 0.30" (8.0 mm x 8.0 mm) copper pad areas

Typical Characteristics

FIG.1: FORWARD CURRENT DERATING CURVE

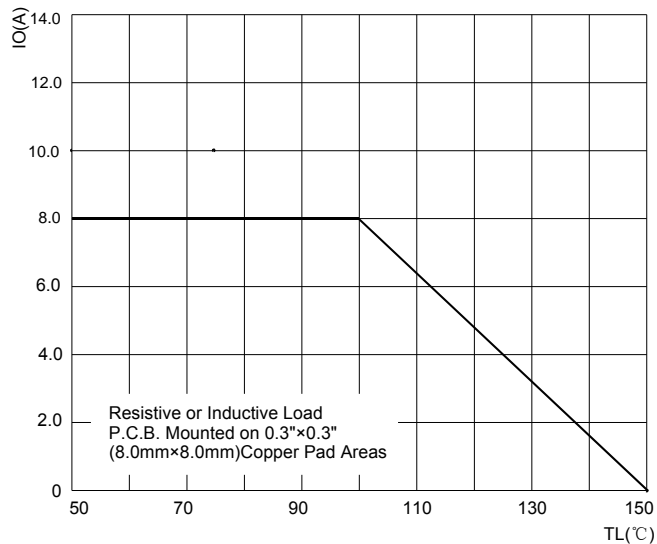

FIG.2: MAXIMUM NON-REPETITIVE FORWARD URGE CURRENT

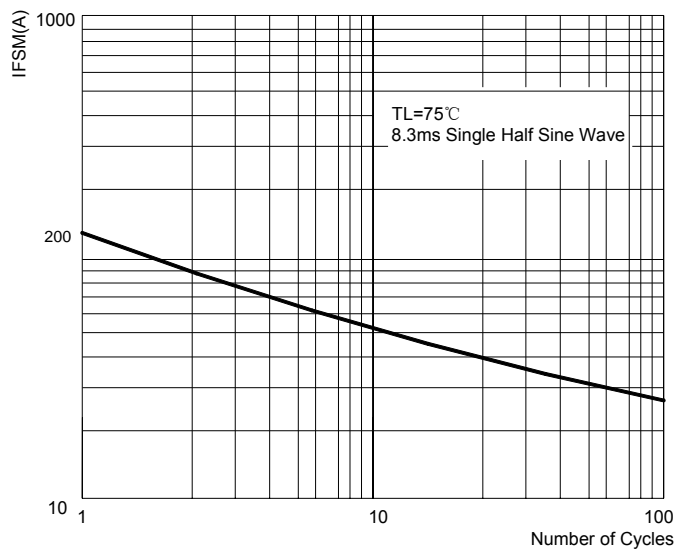

FIG.3: TYPICAL FORWARD CHARACTERISTICS

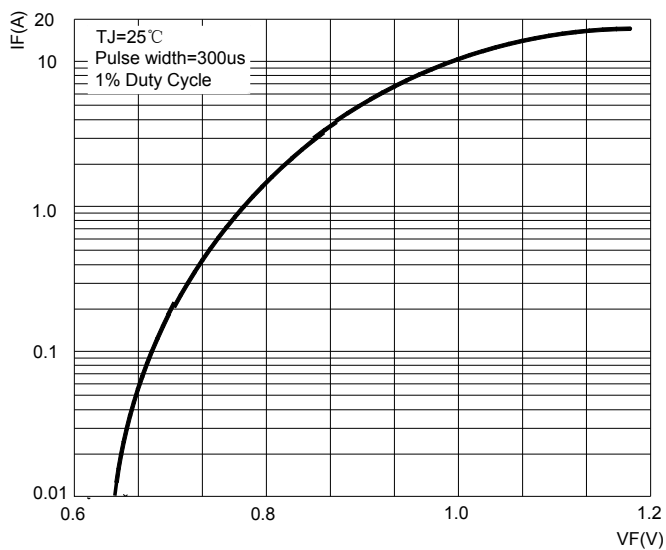
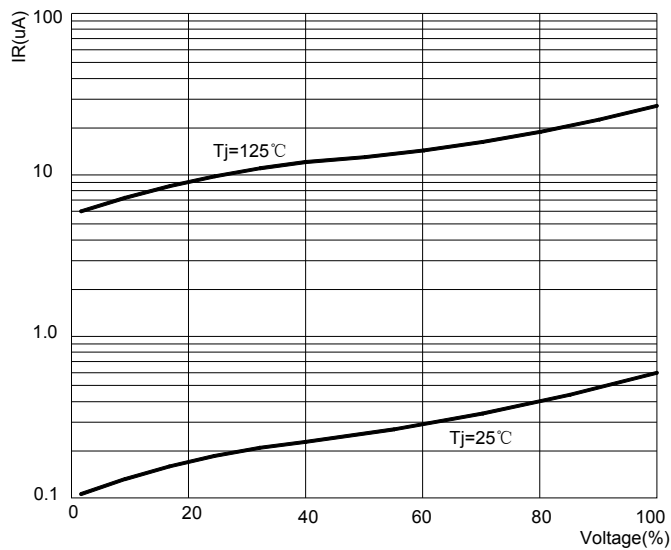
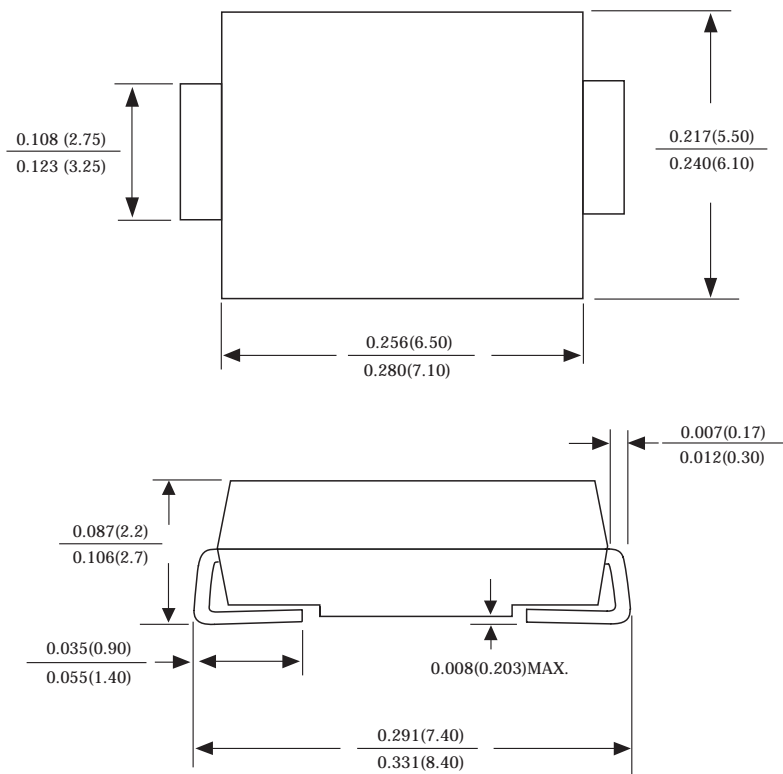

FIG.4: TYPICAL REVERSE CHARACTERISTICS



SMC Package Outline Dimensions



Dimensions in inches and (millimeters)

SMC Suggested Pad Layout

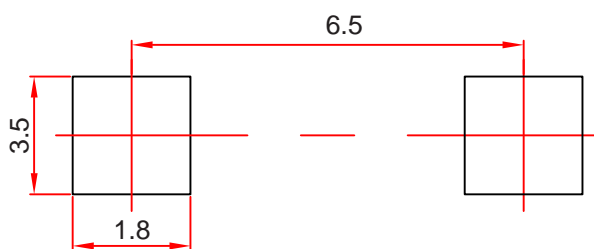

Note:

1. Controlling dimension: in millimeters.
2. General tolerance: $\pm 0.05\text{mm}$.
3. The pad layout is for reference purposes only.

Reel Taping Specifications For Surface Mount Devices–SMC



FIG: CONFIGURATION OF SURFACE MOUNTED DEVICES TAPING

ITEM	SYMBOL	SMC mm(inch)
Carrier width	A	6.05±0.1(0.238±0.004)
Carrier length	B	8.31±0.1(0.327±0.004)
Carrier depth	C	2.70±0.1(0.106±0.004)
Sprocket hole	d	1.55±0.05(0.061±0.002)
Reel outside diameter	D	330±2.0(13±0.079)
Reel inner diameter	D1	75 ±1.0 (2.95 ±0.039)
Feed hole diameter	D2	13±0.5(0.512±0.020)
Strocket hole position	E	1.75 ±0.1(0.069±0.004)
Punch hole position	F	7.65±0.05(0.301±0.002)
Punch hole pitch	P	8.0±0.1(0.315±0.004)
Sprocket hole pitch	P0	4.0±0.1(0.157±0.004)
Embossment center	P1	2.0±0.1(0.079±0.004)
Total tape thickness	T	0.3 ± 0.1 (0.012 ±0.004)
Tape width	W	16.0±0.2(0.630±0.008)
Reel width	W1	24.0±2.0(0.945±0.079)

NOTE: Devices are packed in accordance with EIA standard RS-481-A and specification given above.