



ABS Plastic-Encapsulate Bridge Rectifier

ABS202 THRU ABS210 General Purpose Bridge Rectifier

Features

- $I_{F(AV)}$ 2A
- V_{RRM} 200V-1000V
- High surge current capability
- Glass passivated chip

Applications

- General purpose 1 phase Bridge rectifier applications

Marking

- ABS2XX
X : From 02 To 10

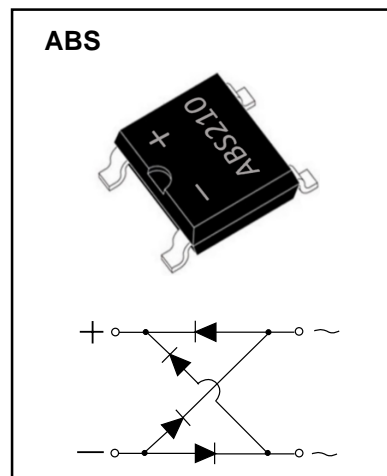

Limiting Values (Absolute Maximum Rating)

Item	Symbol	Unit	Conditions	ABS				
				202	204	206	208	210
Repetitive Peak Reverse Voltage	V_{RRM}	V		200	400	600	800	1000
Maximum RMS Voltage	V_{RMS}	V		140	280	420	560	700
Average Rectified Output Current	I_o	A	60Hz sine wave, R-load, $T_a=115^\circ\text{C}$	On alumina substrate		2.0		
Surge(Non-repetitive)Forward Current	I_{FSM}	A	8.3ms sine wave, 1 cycle, $T_j=25^\circ\text{C}$		75			
			1.0ms sine wave, 1 cycle, $T_j=25^\circ\text{C}$		120			
Current Squared Time	I^2t	A^2S	$1\text{ms} \leq t < 8.3\text{ms}$ $T_j=25^\circ\text{C}$, Rating of per diode		14.94			
Maximum Reverse Recovery Time	T_{RR}	ns	Measured with $I_F=0.5\text{A}$, $I_R=1\text{A}$, $I_{RR}=0.25\text{A}$		4000			
Operation Junction and Storage Temperature Range	T_j, T_{stg}	$^\circ\text{C}$			-55 ~+150			

Electrical Characteristics ($T=25^\circ\text{C}$ Unless otherwise specified)

Item	Symbol	Unit	Test Condition	Max
Peak Forward Voltage	V_{FM}	V	$I_{FM}=2.0\text{A}$, Pulse measurement, Rating of per diode	0.95
Peak Reverse Current	I_{RRM}	μA	$V_{RM}=V_{RRM}$, Pulse measurement, Rating of per diode	5
Thermal Resistance	$R_{\theta J-A}$	$^\circ\text{C/W}$	Between junction and ambient, On alumina substrate	62.5
	$R_{\theta J-L}$		Between junction and lead	25
	$R_{\theta J-C}$		Between junction and case	25

Typical Characteristics

FIG.1: FORWARD CURRENT DERATING CURVE

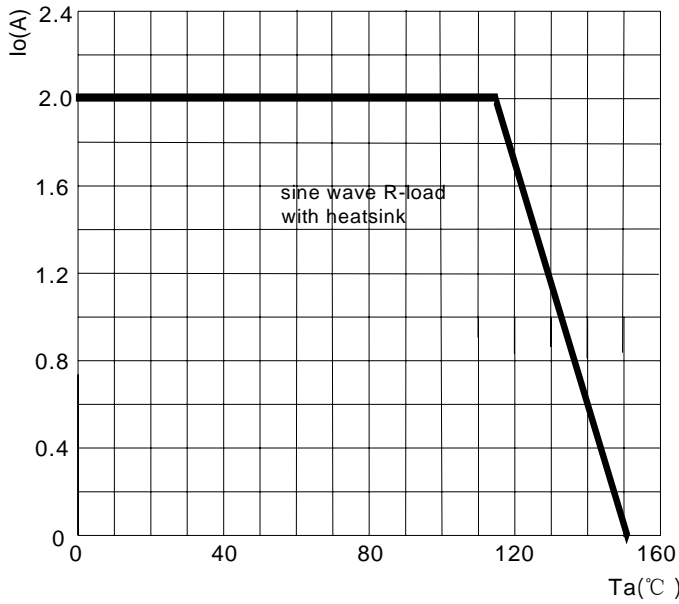

FIG.2: MAXIMUM NON-REPETITIVE FORWARD SURGE CURRENT

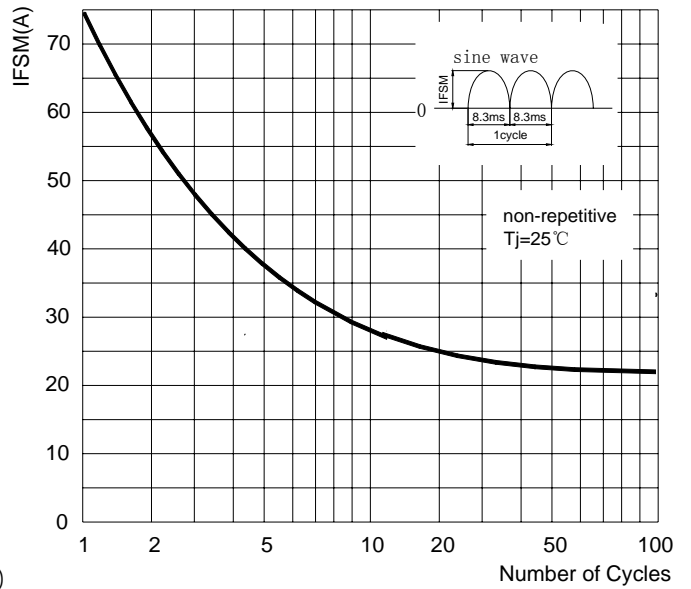

FIG.3: TYPICAL FORWARD CHARACTERISTICS

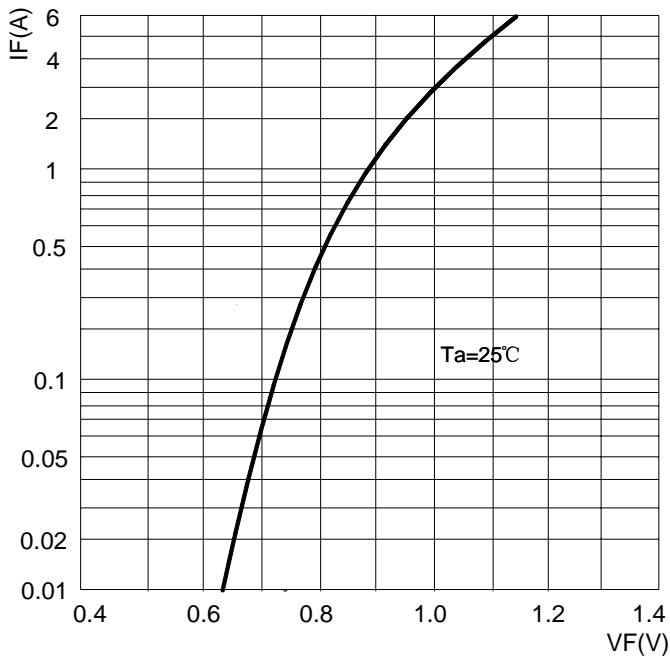

FIG.4: TYPICAL REVERSE CHARACTERISTICS

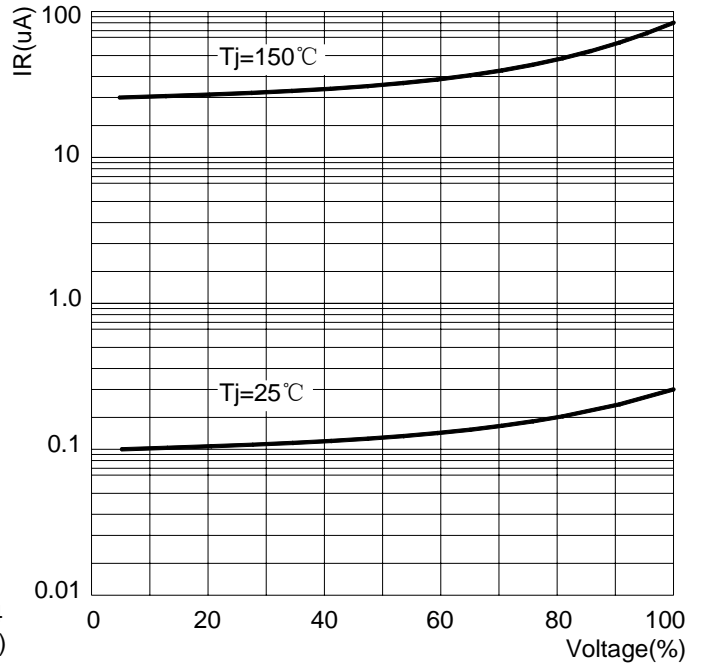
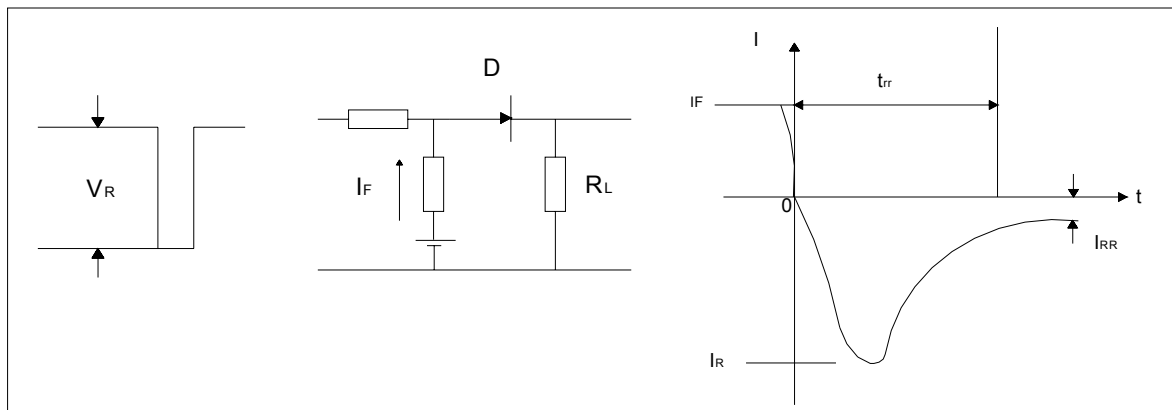
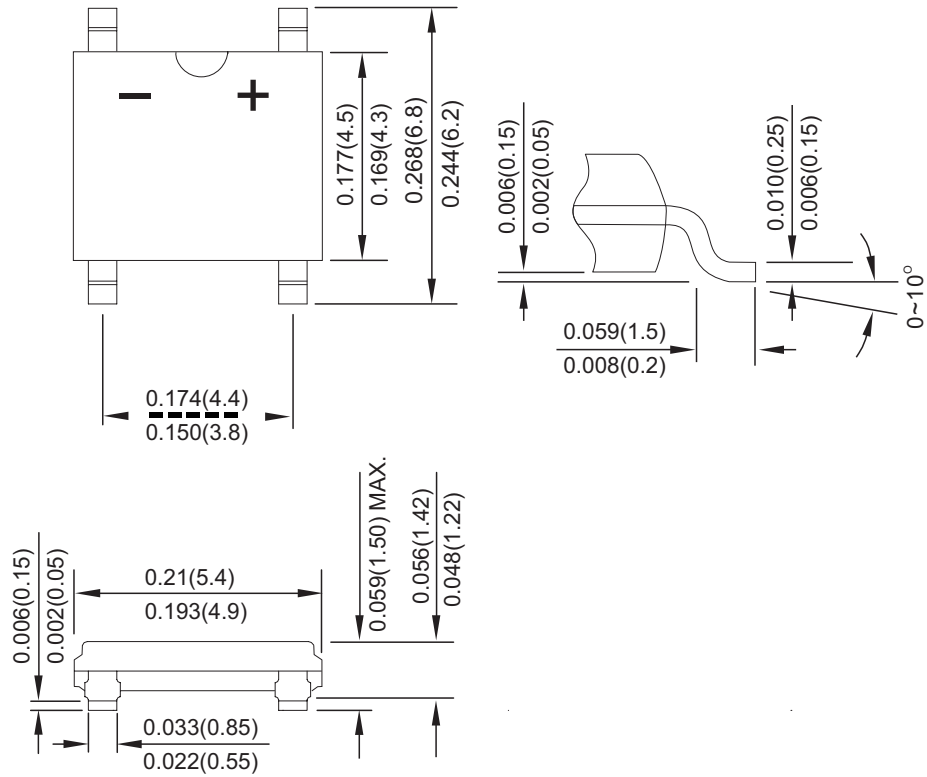

FIG.5: Diagram of circuit and Testing wave form of reverse recovery time



ABS Package Outline Dimensions



Dimensions in inches and (millimeters)

ABS Suggested Pad Layout

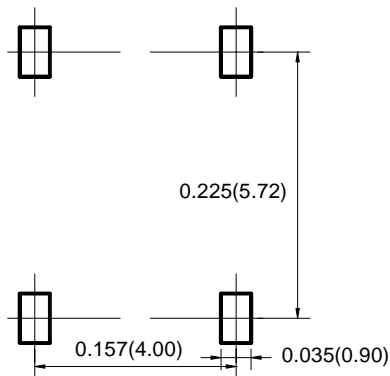

Note:

1. Controlling dimension: in millimeters.
2. General tolerance: $\pm 0.05\text{mm}$.
3. The pad layout is for reference purposes only.

Reel Taping Specifications For Surface Mount Devices-ABS

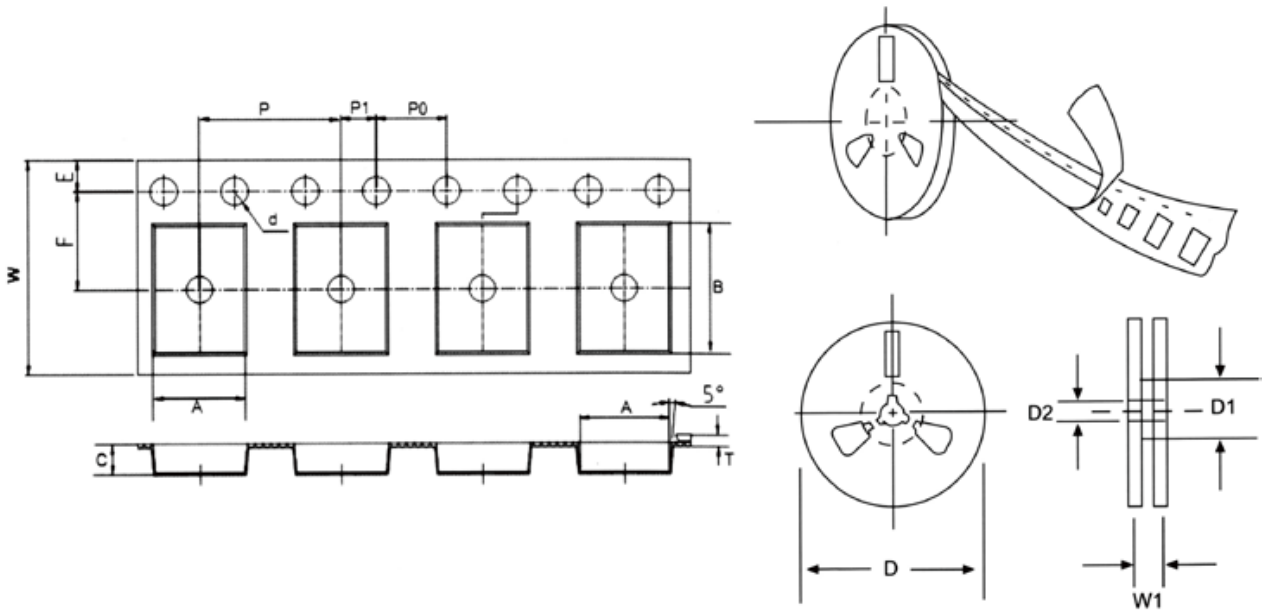

FIG: CONFIGURATION OF SURFACE MOUNTED DEVICES TAPING

ITEM	SYMBOL	ABS mm(inch)
Carrier width	A	5.40±0.1(0.213±0.004)
Carrier length	B	6.90±0.05(0.272±0.002)
Carrier depth	C	2.10±0.1(0.083±0.004)
Sprocket hole	d	1.55±0.05(0.061±0.002)
Reel outside diameter	D	279±2.0 (11± 0.079)
Reel inner diameter	D1	75 ±1.0 (2.95 ±0.039)
Feed hole diameter	D2	13±0.5(0.512±0.020)
Strocket hole position	E	1.75±0.1(0.069±0.004)
Punch hole position	F	5.5±0.05(0.217±0.002)
Punch hole pitch	P	8.0±0.1(0.315±0.004)
Sprocket hole pitch	P0	4.0±0.1(0.157±0.004)
Embossment center	P1	2.0±0.1(0.079±0.004)
Totall tape thickness	T	0.10-0.70(0.004-0.028)
Tape width	W	12.0±0.3/-0.1(0.472±0.004)
Reel width	W1	16.8±2.0(0.661±0.079)

NOTE: Devices are packde in accordance with EIA standard RS-481-A and specification given above.