



DONGGUAN NANJING ELECTRONICS LTD.,
TO-247 Silicon Carbide Schottky Diode

NJ12020T2 SiC Diode 1200V, 20A, 107nC

General Description

This product family offers state of the art performance. It is designed for high frequency applications here high efficiency and high reliability are required.

Features

- Max junction temperature 175°C
- High surge current capacity
- Zero reverse recovery current
- Zero forward recovery voltage
- High frequency operation
- Temperature independent switching behavior
- Positive temperature coefficient on V_F



TO-247
Pin definition

Applications

- Solar booster
- Inverter free wheeling diode
- Vienna 3-Phase PFC
- EV charger piles
- Switch Mode Power Supplies

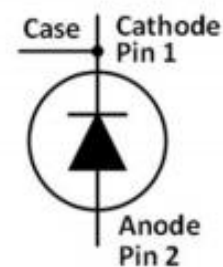

Key performance parameters

Type	V_{RRM}	I_F $T_C=151^\circ\text{C}$	Q_C
NJ12020T2	1200V	20A	107nC

Caution: This device is sensitive to electrostatic discharge .Users should follow ESD handling procedures.

Typical Characteristics

Maximum Ratings

$T_C=25^{\circ}\text{C}$, unless otherwise specified

Parameter	Symbol	Value	Unit
Repetitive Peak Reverse Voltage	V_{RRM}	1200	V
DC Peak Reverse Voltage	V_{DC}	1200	V

Maximum Ratings

$T_C=25^{\circ}\text{C}$, unless otherwise specified

Parameter	Symbol	Value	Unit
Continuous Forward Current: $T_C = 25^{\circ}\text{C}$ $T_C = 151^{\circ}\text{C}$	I_F	54 20	A
Non-Repetitive Forward Surge Current: Sine half wave $T_C = 25^{\circ}\text{C}$ $t_p = 10\text{ms}$	I_{FSM}	140	A
Power Dissipation: $T_C = 25^{\circ}\text{C}$ $T_C = 150^{\circ}\text{C}$	P_{tot}	272 45	W
i^2t value : $T_C = 25^{\circ}\text{C}$ $t_p = 10\text{ms}$	$\int i^2 dt$	98	A^2S
Operating Junction temperature Range	T_j	-55 to +175	$^{\circ}\text{C}$
Storage temperature Range	T_{stg}	-55 to +175	$^{\circ}\text{C}$

Typical Characteristics

Thermal Resistance

Parameter	Symbol	Typ.	Unit
Thermal resistance of crust	R_{thJC}	0.55	$^{\circ}C/W$

Electrical Characteristic

$T_C = 25^{\circ}C$, unless otherwise specified

Parameter	Symbol	Value			Unit	Test Condition
		Min.	Typ.	Max.		
Forward Voltage	V_F		1.56 2.25	1.8 3.0	V	$I_F = 20A$ $T_j = 25^{\circ}C$ $T_j = 175^{\circ}C$
Reverse Current	I_R		10 45	120 450	μA	$V_R = 1200V$ $T_j = 25^{\circ}C$ $T_j = 175^{\circ}C$
Total Capacitive Charge	Q_C		107		nC	$V_R = 800V$ $T_j = 25^{\circ}C$ $Q_C = \int_0^{V_R} C(V)dV$
Total Capacitance	C		1114 100 77		pF	$T_j = 25^{\circ}C, f = 1MHz$ $V_R = 1V$ $V_R = 400V$ $V_R = 800V$

Characteristics Curves

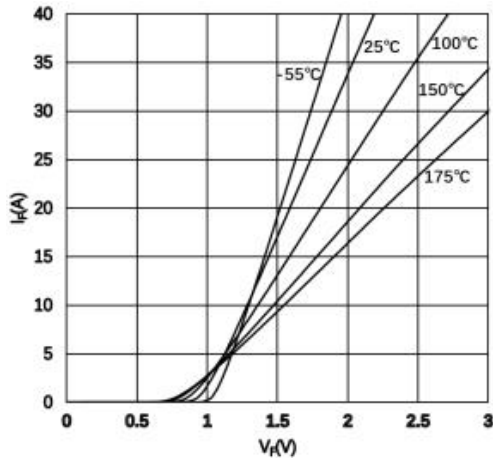

Fig. 1 Typical forward characteristic curve

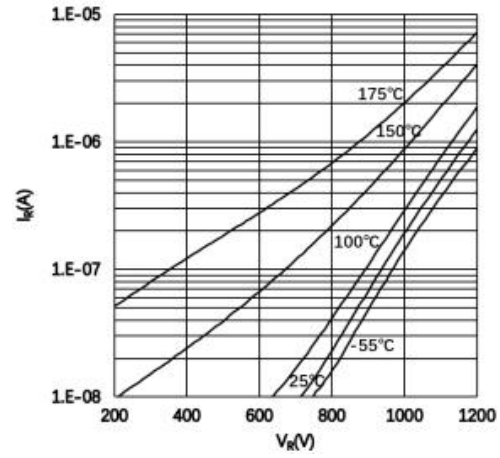

Fig. 2 Typical reverse characteristic curve

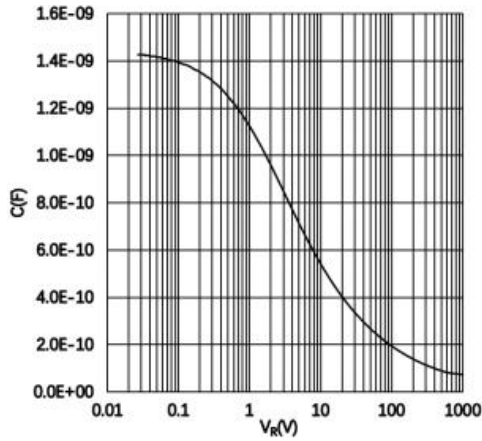

Fig. 3 Typical capacitance and reverse voltage curve

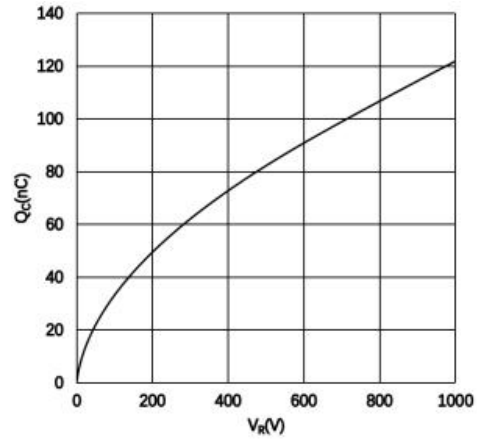

Fig. 4 Typical storage charge and reverse voltage curve

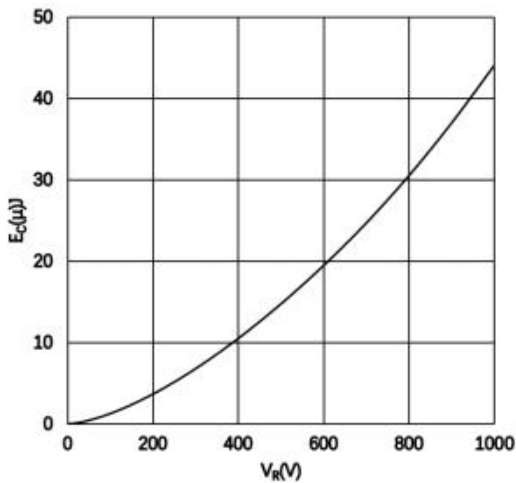

Fig. 5 Typical capacitance energy and reverse voltage curve

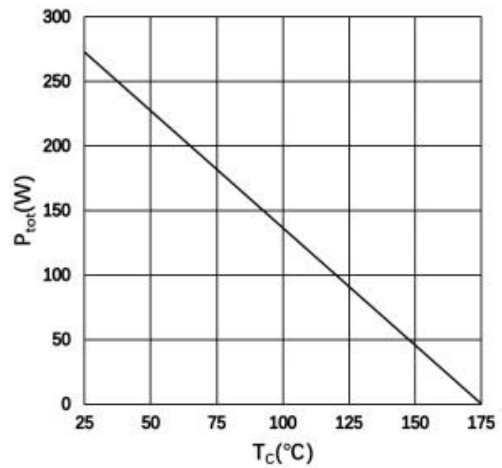

Fig. 6 Typical power derating curve

Typical Characteristics

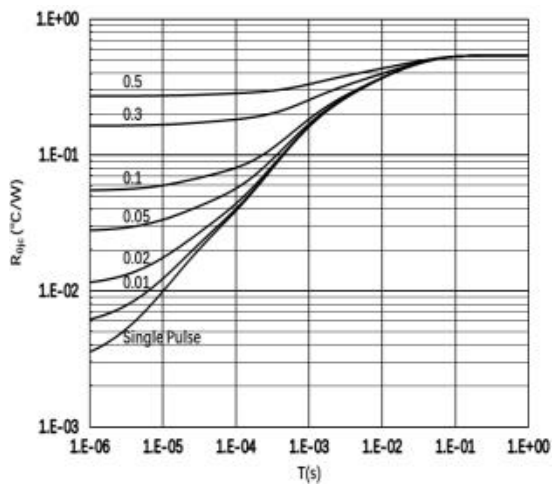

Fig. 7 Transient thermal impedance

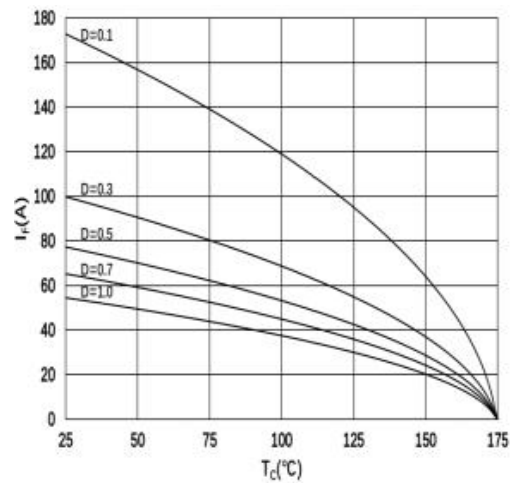
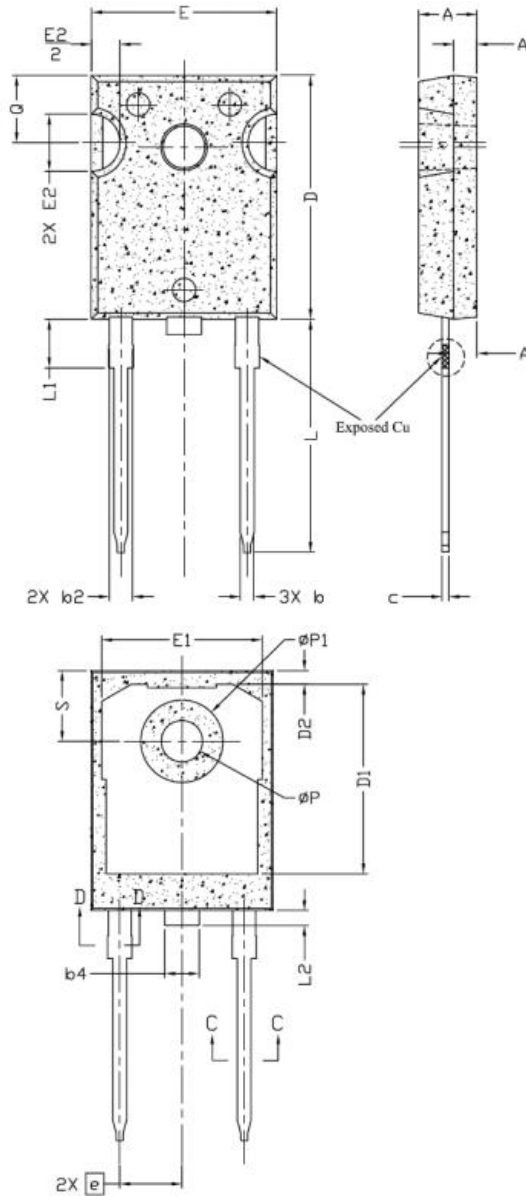

Fig. 8 Current curve under different loads

Package Outline:TO-247-2



SYMBOL	DIMENSIONS			NOTES
	MIN.	NOM.	MAX.	
A	4.83	5.02	5.21	
A1	2.29	2.41	2.55	
A2	1.50	2.00	2.49	
b	1.12	1.20	1.33	
b1	1.12	1.20	1.28	
b2	1.91	2.00	2.39	6
b3	1.91	2.00	2.34	
b4	2.87	3.00	3.22	6, 8
b5	2.87	3.00	3.18	
c	0.55	0.60	0.69	6
c1	0.55	0.60	0.65	
D	20.80	20.95	21.10	4
D1	16.25	16.55	17.65	5
D2	0.51	1.19	1.35	
E	15.75	15.94	16.13	4
E1	13.46	14.02	14.16	5
E2	4.32	4.91	5.49	3
e	5.44BSC			
L	19.81	20.07	20.32	
L1	4.10	4.19	4.40	6
L2	1.00	1.30	1.50	
ϕP	3.56	3.61	3.65	7
$\phi P1$	6.90	7.09	7.15	
Q	5.39	5.79	6.20	
S	6.04	6.17	6.30	

Dimensions in (mm)

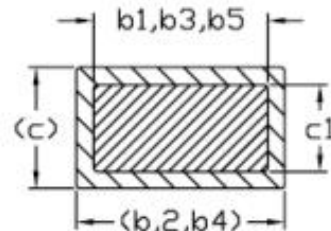

Section C-C, D-D